

# BG Transmission Service

## Adaptor Guide

For

BG PXT<sup>®</sup>2 Performance Exchange<sup>®</sup> for Transmissions and Power Steering, PN E101-2012 (1402 series)

BG PXT<sup>®</sup> Performance Exchange<sup>®</sup> for Transmissions, (1401 series)

BG PF5HO High Output Power Flush and Fluid Exchange System, PN E100-2664



# Transmission Service Adaptors

For use with all BG transmission machines

**RED** characters in part numbers are marked on adaptors

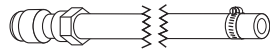

E100-1621  
**BA02**, 1/4 open hose  
transmission adaptor, Mate BA03



E100-1619  
**BA03**, 1/4 & 5/16 barb transmission  
adaptor, Mate BA02, BA04



E100-1618  
**BA04**, 5/16 open hose  
transmission adaptor, Mate BA03



E100-1616  
**BA06**, 3/8 open hose transmission  
adaptor, Mate BA07



E100-1612  
**BA07**, 3/8 & 1/2 barb transmission  
adaptor, Mate BA06, BA08



E100-1611  
**BA08**, 1/2 open hose transmission  
adaptor, Mate BA07

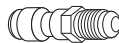

E100-1609  
**BA09**, Volvo, Isuzu, Jeep 3/8 male  
flare 5/8-18 transmission adaptor,  
Mate BA10

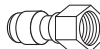

E100-1580  
**BA10**, Volvo, Isuzu, Jeep 3/8 female  
flare 5/8-18 transmission adaptor,  
Mate BA09



E100-1558  
**BA11**, GM 5/16 male inverted flare  
1/2-20 transmission adaptor,  
Mate BA12



E100-1536  
**BA12**, GM 5/16 female inverted  
flare 1/2-20 transmission adaptor,  
Mate BA11



E100-1531  
**BA13**, 1/4 -18 male pipe thread  
transmission adaptor, Mate BA14



E100-1529  
**BA14**, 1/4 -18 female pipe thread  
transmission adaptor, Mate BA13

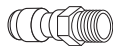

E100-1528  
**BA15**, Jeep, GM 3/8 male inverted  
flare 5/8-18 transmission adaptor,  
Mate BA22



E100-1527  
**BA16**, GM 1/2 male inverted flare  
3/4-18 transmission adaptor,  
Mate BA37



E100-1526  
**BA17**, Ford 3/8 male long inverted flare  
5/8-18 transmission adaptor,  
Mate BA32

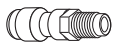

E100-1525  
**BA18**, Ford 5/16 male long inverted  
flare 1/2-20 transmission adaptor,  
Mate BA31



E100-1523  
**BA19**, PF5 recharge adaptor

E100-1522  
5/8 x 1/4 hex bushing

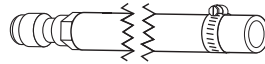

E100-1520  
**BA20**, 3/4 open hose  
transmission adaptor



E100-1518  
**BA21**, GM 5/16 male JIC 1/2-20  
transmission adaptor, Mate BA23

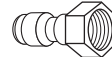

E100-1517  
**BA22**, Jeep, GM 3/8 female inverted  
flare 5/8-18 transmission adaptor,  
Mate BA15



E100-1516  
**BA23**, GM 5/16 female JIC 1/2-20  
transmission adaptor, Mate BA21



E100-1515  
**BA24**, 7/16 inverted flare 11/16-18  
transmission adaptor, Mate BA38

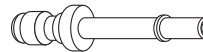

E100-1514  
**BA25**, Ford, CDJR 3/8 male  
spike QC transmission adaptor,  
Mate BA72

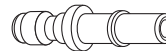

E100-1513  
**BA26**, CDJR 1/2 male spike QC  
transmission adaptor, Mate BA79



E100-1512  
**BA27**, Ford 5/16 spike QC  
transmission adaptor, Mate BA80



E100-1511  
**BA28**, GM, CDJR, Mercedes 3/8  
male QC transmission adaptor,  
Mate BA72

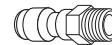

E100-1510  
**BA29**, Ford 3/8 male flare 5/8 -18  
transmission adaptor, Mate BA30

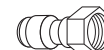

E100-1508  
**BA30**, Ford 3/8 female flare 5/8-18  
transmission adaptor, Mate BA29



E100-1501  
**BA31**, Ford 5/16 female long inverted  
flare 1/2-20 transmission adaptor,  
Mate BA18

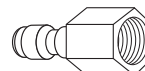

E100-1498  
**BA32**, Ford 3/8 female long inverted  
flare 5/8-18 transmission adaptor,  
Mate BA17

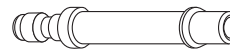

E100-1495  
**BA33**, GM, Ford, Mercedes 1/2 male QC  
transmission adaptor, Mate BA79



E100-1493  
**BA34**, 3/8 male JIC flare 9/16 -18  
transmission adaptor, Mate BA39



E100-1491  
**BA35**, Ford Escort male banjo  
M14-1.5 transmission adaptor.  
Use with BA06, Mate BA36



E100-1489  
**BA36**, Ford Escort female banjo  
M14-1.5 transmission adaptor.  
(use with factory banjo bolt) Mate BA35



E100-1486  
**BA37**, GM 1/2 female inverted flare  
3/4 -18 transmission adaptor,  
Mate BA16











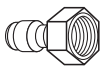
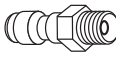
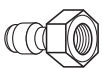
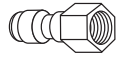
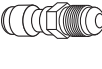
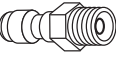
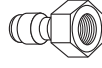
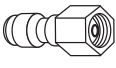
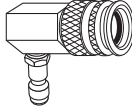
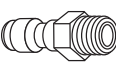
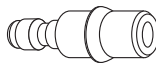
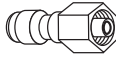
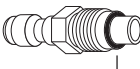
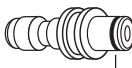

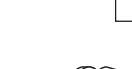
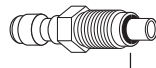
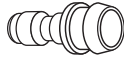

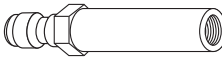
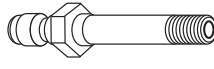
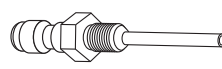
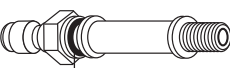

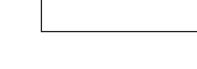
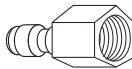
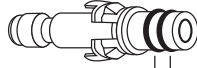
*continued on next page*

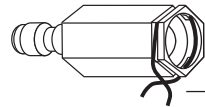
# Transmission Service Adaptors *continued*

For use with all BG transmission machines

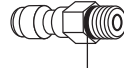
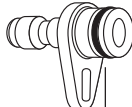
**RED** characters in part numbers are marked on adaptors

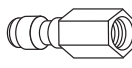
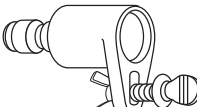
- |   |  |  |   |
|---|--|--|---|
|    | E100-1483<br><b>BA38</b> , 7/16 female inverted flare 1 1/16 -18 transmission adaptor, Mate BA24 |    | E100-1449<br><b>BA52</b> , BMW, Mercedes male flare M16-1.5 transmission adaptor, Mate BA52F      |
|    | E100-1480<br><b>BA39</b> , 3/8 female JIC flare 9/16 -18 transmission adaptor, Mate BA34         |    | E100-1488<br><b>BA52F</b> , BMW, Mercedes female flare M16-1.5 transmission adaptor, Mate BA52    |
|    | E100-1477<br><b>BA40</b> , CDJR 5/16 male flare 9/16 -24 transmission adaptor, Mate BA41         |    | E100-1445<br><b>BA53</b> , BMW, Audi male flare M18-1.5 transmission adaptor, Mate BA53F          |
|    | E100-1475<br><b>BA41</b> , CDJR 5/16 female flare 9/16 -24 transmission adaptor, Mate BA40       |    | E100-1444<br><b>BA53F</b> , BMW, Audi female flare M18-1.5 transmission adaptor, Mate BA53, BA135 |
|    | E100-1472<br><b>BA42</b> , 90° QC transmission adaptor   |    | E100-1441<br><b>BA54</b> , BMW male O-ring M18-1.5 transmission adaptor, Mate BA54F               |
|    | E100-1470<br><b>BA43</b> , GM 5/8 QC male transmission adaptor, Mate BA73                        |    | E100-1440<br><b>BA54F</b> , BMW female O-ring M18-1.5 transmission adaptor, Mate BA54             |
|    | E100-1468<br><b>BA44</b> , Jaguar, Land Rover male M18-1.5 transmission adaptor, Mate BA76       |    | E100-1437<br><b>BA55</b> , Volvo male transmission adaptor, Mate BA55F                            |
|    | E100-3921<br>O-Ring, Buna, -013 (0.426 ID x .070)  |    | E100-7014<br>O-Ring, Buna, -014 (.489 ID x .070)  |
|   | E100-1466<br><b>BA45</b> , CDJR male 5/8 -18 transmission adaptor, Mate BA77                     |    | E100-1434<br><b>BA55F</b> , Volvo female transmission adaptor, Mate BA55                          |
|  | E100-3923<br>O-Ring, Buna, -011 (.301 ID x .070)   |   | E100-1436<br><b>BA55C</b> , BA55 retaining clip   |
|  | E100-1464<br><b>BA46</b> , Honda, Acura female banjo M12-1.25 transmission adaptor, Mate BA47    |  | E100-1433<br><b>BA56</b> , VW, Audi single flange bolt transmission adaptor, (service requires 2) |
|  | E100-1463<br><b>BA47</b> , Honda, Acura male banjo M12-1.25 transmission adaptor, Mate BA46      |  | E100-1432<br><b>BA57</b> , VW, Audi double flange bolt transmission adaptor, (service requires 2) |
|  | E100-1462<br><b>BA48</b> , CDJR male 1 1/16 -16 transmission adaptor, Mate BA49                  |  | E100-3910<br>O-ring, Buna, -206 (.484 ID x .139)  |
|  | E100-1459<br><b>BA49</b> , CDJR female 1 1/16 -16 transmission adaptor, Mate BA48                |  | E100-1431<br><b>BA58</b> , Volvo male transmission adaptor with plastic clip, Mate BA58F          |
|  | E100-1456<br><b>BA50</b> , BMW 12mm male spike QC transmission cooler adaptor, Mate BA50F        |  | E100-3921<br>O-ring, Buna, -206 (.484 ID x .139)  |
|  | E100-1454<br><b>BA50F</b> , BMW 12mm female QC transmission cooler adaptor, Mate BA50            |  | E100-1429<br><b>BA58C</b> , BA58 adaptor clip   |
|  | E100-1455<br>Retainer wire, R.235  |  | E100-1428<br><b>BA58F</b> , Volvo female transmission adaptor, Mate BA58                          |
|  | E100-1452<br><b>BA51</b> , Saab male M14-1.5mm transmission adaptor, Mate BA51F                  |  | E100-1426<br><b>BA59</b> , Audi, VW, Porsche, BMW 16.4mm male transmission adaptor, Mate BA59F    |
|  | E100-3921<br>O-Ring, Buna, -013 (0.426 ID x .070)  |  | E100-7001<br>O-ring, Buna, -112 (.487 ID x .103)  |
|  | E100-1451<br><b>BA51F</b> , Saab, Land Rover female M14-1.5mm transmission adaptor, Mate BA51    |  | E100-1425<br><b>BA59F</b> , Audi, VW, Porsche, BMW 16.4mm female transmission adaptor, Mate BA59  |



*continued on next page*

# Transmission Service Adaptors *continued*

For use with all BG transmission machines

**RED** characters in part numbers are marked on adaptors

- 

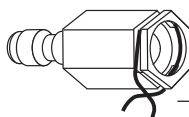
E100-1423  
**BA60**, Mercedes male QC transmission adaptor, Mate BA60F
- 

E100-1422  
**BA60F**, Mercedes female QC transmission adaptor, Mate BA60
- 

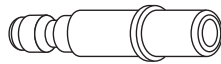
E100-1388  
Retainer wire, R.340
- 

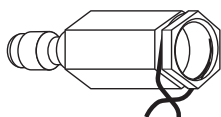
E100-1421  
**BA61**, BMW, Land Rover 14mm male QC transmission adaptor, Mate BA61F
- 

E100-1420  
**BA61F**, BMW, Land Rover 14mm female QC transmission adaptor, Mate BA61
- 

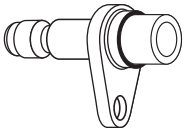
E100-1373  
Retainer wire R.273
- 

E100-1419  
**BA62**, Volvo 12mm male transmission adaptor, Mate BA62F
- 

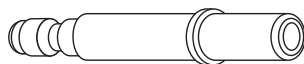
E100-1418  
**BA62F**, Volvo 12mm female transmission adaptor, Mate BA62
- 

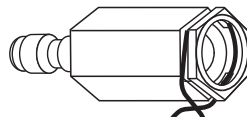
E100-1405  
**BA66**, BMW 14.3mm male transmission adaptor, Mate BA66F
- 

E100-1404  
**BA66F**, BMW 14.3mm female transmission adaptor, Mate BA66
- 

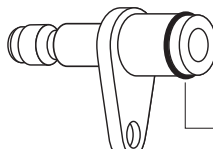
E100-1388  
Retainer wire, R.340
- 

E100-1403  
**BA67**, Audi 14.8mm male transmission adaptor, Mate BA67F
- 

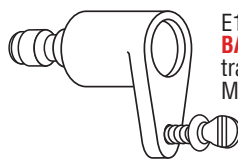
E100-7002  
O-Ring, Buna, -.111 (.424 ID x .103)
- 

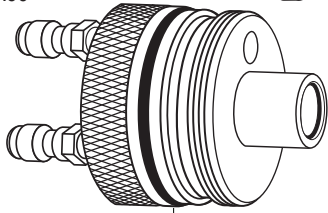
E100-1400  
**BA67F**, Audi 14.8mm female transmission adaptor, Mate BA67
- 

E100-1398  
**BA68**, VW, Audi DSG transmission adaptor, (spins on in place of the filter housing)
- 

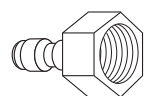
E100-6988  
230-70 Buna O-Ring
- 

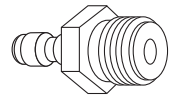
E100-1395  
**BA70**, Land Rover female M20-1.5 transmission adaptor, Mate BA71
- 

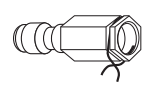
E100-1394  
**BA71**, Land Rover, Honda male M20-1.5 transmission adaptor, Mate BA70
- 

E100-1393  
**BA72**, GM, CDJR, Mercedes 3/8 female QC transmission adaptor, Mate BA25, BA28, BA113
- 

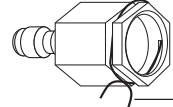
E100-1390 Retainer wire R.210
- 

E100-1386  
**BA73**, GM 5/8 Female QC transmission adaptor, Mate BA43
- 

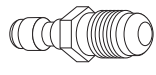
E100-1388 Retainer wire R.340
- 

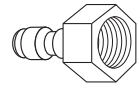
E100-1381  
**BA74**, Isuzu Cabover male M16-1.5 transmission adaptor, Mate BA75
- 

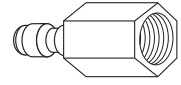
E100-1380  
**BA75**, Isuzu Cabover female M16-1.5 transmission adaptor, Mate BA74
- 

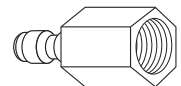
E100-1379  
**BA76**, Jaguar, Land Rover female M18-1.5 transmission adaptor, Mate BA44
- 

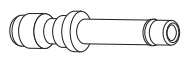
E100-1378  
**BA77**, CDJR female 5/8-18 transmission adaptor, Mate BA45
- 

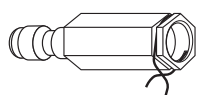
E100-1375  
**BA78**, Ford, GM 3/8 male QC transmission adaptor, Mate BA06
- 

E100-1372  
**BA79**, CDJR, Mercedes, Ford, GM 1/2 female QC transmission adaptor, Mate BA26, BA33, BA141
- 

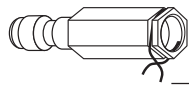
E100-1373 retainer wire, R.273
- 

E100-1367  
**BA80**, Ford 5/16 female QC transmission adaptor, Mate BA27
- 

E100-1365 retainer wire, R.179



*continued on next page*

# Transmission Service Adaptors *continued*

For use with all BG transmission machines

**RED** characters in part numbers are marked on adaptors

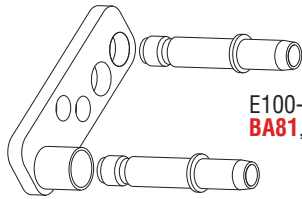

E100-1364  
**BA81**, Saturn transmission adaptor

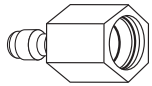

E100-1360  
**BA82**, Allison, Chevy Workhorse female QC transmission adaptor, Mate BA83

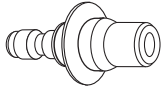

E100-1358  
**BA83**, Allison, Chevy Workhorse male QC transmission adaptor, Mate BA82

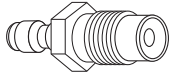

E100-1354  
**BA84**, 1/2 male long inverted flare 3/4-18 transmission adaptor, Mate BA85

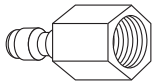

E100-1351  
**BA85**, 1/2 female long inverted flare 3/4-18 transmission adaptor, Mate BA84

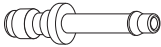

E100-1348  
**BA86**, GM, CDJR, Mercedes long male QC transmission adaptor, Mate BA28

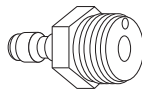

E100-1347  
**BA87**, used oil drum plug adaptor 3/4-14

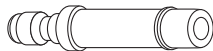

E100-1345  
**BA88**, Ford 1/2 male QC transmission adaptor, Mate BA08

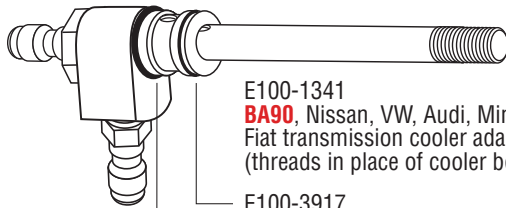

E100-1341  
**BA90**, Nissan, VW, Audi, Mini, Fiat transmission cooler adaptor (threads in place of cooler bolt)

E100-3917  
O-ring, .676 ID x .070 THK, -017, Buna

E100-7012  
O-ring, Buna, -016 (.614 X .07)

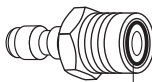

E100-1340  
**BA91**, GM male M18-1.5 transmission adaptor, Mate BA92

E100-3922  
O-Ring, -012, Buna

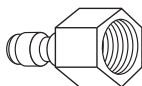

E100-1338  
**BA92**, GM female M18-1.5 transmission adaptor, Mate BA91

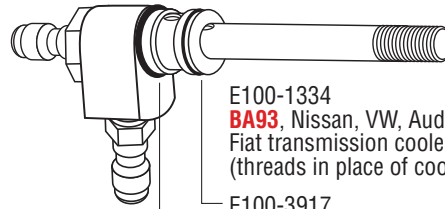

E100-1334  
**BA93**, Nissan, VW, Audi, Mini, Fiat transmission cooler adaptor (threads in place of cooler bolt)

E100-3917  
O-ring, .676 ID x .070 THK, -017, Buna

E100-7012  
O-ring, Buna, -016 (.614 X .070)

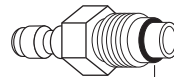

E100-1333  
**BA97**, Ford F150 male thermostat 1/2-20 transmission adaptor, Mate BA98

E100-7058  
-010 Atlas O-Ring (0.239 ID x .070) (used for BA97)

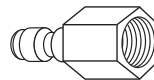

E100-1331  
**BA98**, Ford F150 female thermostat 1/2-20 transmission adaptor, Mate BA97



E100-1328  
**BA99**, Ford male QC transmission adaptor, Mate BA08

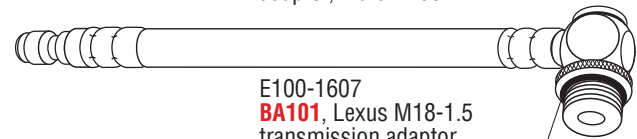

E100-1607  
**BA101**, Lexus M18-1.5 transmission adaptor

E100-1604  
O-Ring, M2 x 16, Buna



E100-1601  
**BA102**, Lexus M14-1.5 transmission adaptor

E100-1599  
O-Ring, M2.5 x12, Buna

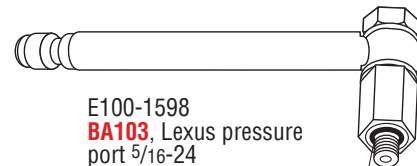

E100-1598  
**BA103**, Lexus pressure port 5/16-24 transmission adaptor

E100-3923  
O-Ring, -011 (.301 ID x .070), Buna



*continued on next page*

# Transmission Service Adaptors *continued*

For use with all BG transmission machines

**RED** characters in part numbers are marked on adaptors

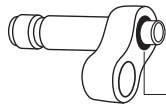

E100-1594  
**BA104**, GM male transmission adaptor, Mate BA105  
E100-3923  
O-Ring, Buna -011 (.301 ID x .070)

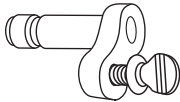

E100-1593  
**BA105**, GM female transmission adaptor, Mate BA104

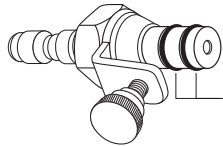

E100-1592  
**BA106**, Nissan CVT dip stick adaptor  
E100-1589  
O-Ring, Buna, M2.5 x 10mm



E100-1588  
**BA107**, Nissan, Ford, CDJR pressure port M10-1.0 transmission adaptor

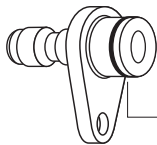

E100-1584  
**BA108**, VW 16.4mm male transmission adaptor, Mate BA109  
E100-7001  
O-Ring, Buna, -112 (.487 ID x .103)

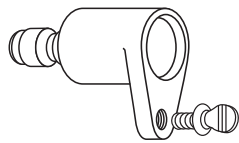

E100-1582  
**BA109**, VW 16.4mm female transmission adaptor, Mate BA108

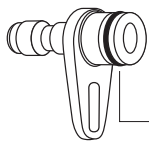

E100-1579  
**BA111**, Ford 18.4mm male transmission adaptor, Mate BA112  
E100-7000  
O-Ring, Buna, -113 (.549 ID x .103)

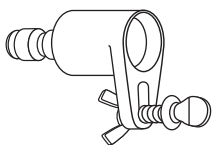

E100-1577  
**BA112**, Ford 18.4mm female transmission adaptor, Mate BA111

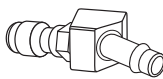

E100-1574  
**BA113**, GM, CDJR, Mercedes male 45° QC transmission adaptor, Mate BA72

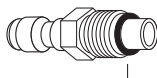

E100-1572  
**BA114**, Ford male thermostat block 3/4-18 transmission adaptor, Mate BA115  
E100-7002  
O-Ring, Buna, -111 (.424 ID x .103)

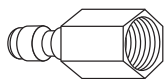

E100-1570  
**BA115**, Ford female thermostat block 3/4-18 transmission adaptor, Mate BA114

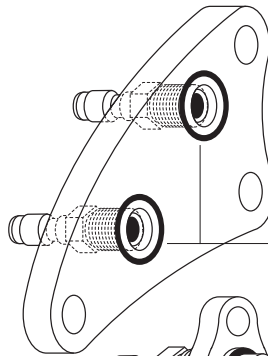

E100-1569  
**BA116**, Mazda transmission plate adaptor (bolts in place of cooler)

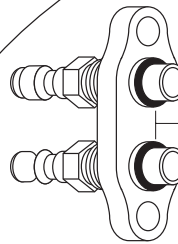

E100-6997  
O-Ring, Buna, -111 (.737 ID x .103)

E100-1566  
**BA117**, Volvo US transmission adaptor

E100-7002  
O-Ring, Buna, -111 (.424 ID x .103)

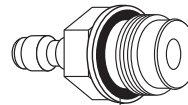

E100-1563  
**BA118**, Ford dipstick fill port M20-1.5 transmission adaptor

E100-6998  
O-Ring, Buna -115 (.674 ID x .103)

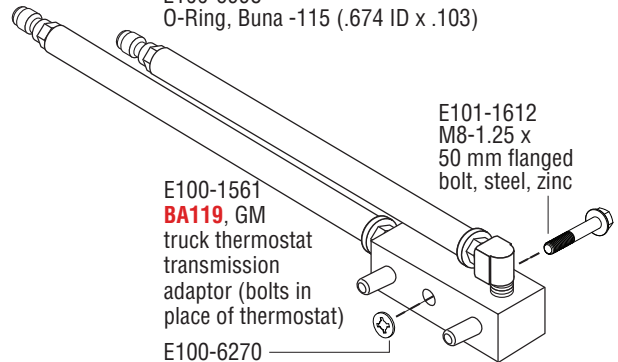

E100-1561  
**BA119**, GM truck thermostat transmission adaptor (bolts in place of thermostat)

E100-6270  
Self-retaining washer, (0.290 ID x .065)

E101-1612  
M8-1.25 x 50 mm flanged bolt, steel, zinc

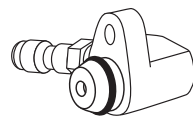

E100-1557  
**BA120**, BMW 18.9mm male transmission adaptor, Mate BA121

E100-7000  
O-Ring, Buna, -113 (.549 ID x .103)

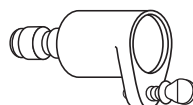

E100-1555  
**BA121**, BMW 18.9mm female transmission adaptor, Mate BA120

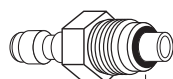

E100-1553  
**BA122**, CDJR male M20-1.5 transmission adaptor, Mate BA123

E100-7003  
O-Ring, Buna, -110 (.362 ID x .103)

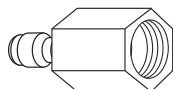

E100-1551  
**BA123**, CDJR female M20-1.5 transmission adaptor, Mate BA122



*continued on next page*

# Transmission Service Adaptors *continued*

For use with all BG transmission machines

**RED** characters in part numbers are marked on adaptors



E100-1550  
**BA124**, Honda, Acura,  
Hyundai, Kia M10-1.25 90°  
swivel transmission adaptor

E100-3923  
O-Ring, Buna, -011  
(.301 ID x .070)

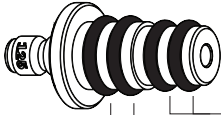

E100-1548  
**BA125**, Honda, Acura  
transmission fill plug adaptor

E101-1286  
O-Ring, Buna, -207 (.546 ID x .139)

E101-1285  
O-Ring, Buna, -208 (.609 ID x .139)

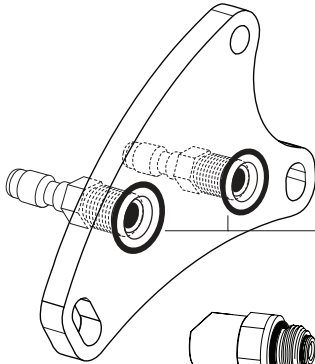

E100-1546  
**BA126**, Toyota, Scion, Mazda  
CVT plate adaptor  
(bolts in place of cooler)

E100-6996  
O-Ring, Buna, -117 (.799 ID x .103)

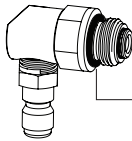

E100-1543  
**BA127**, CDJR, Hyundai, Genesis  
M18-1.5 transmission adaptor

E100-7000  
O-Ring, Buna, -113 (.549 ID x .103)

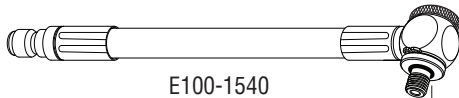

E100-1540  
**BA128**, VW, Volvo 90°  
swivel 5/16-24  
transmission adaptor

E100-7018  
O-Ring, Buna, -010 (.239 ID x .379)

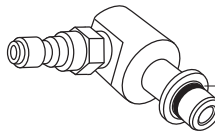

E100-1538  
**BA129**, BMW 6-speed diesel  
transmission adaptor

E100-7001  
O-Ring, Buna, -112 (.487 ID x .103)

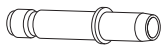

E101-1054  
**BA132**, Audi, Porsche, Hyundai,  
Kia, Genesis 12mm male  
transmission adaptor,  
Mate BA08



E101-1218  
**BA133**, Nissan, Mitsubishi  
M14-1.0 CVT adaptor

E100-3921  
O-Ring, Buna, -013 (0.426 ID x .070)

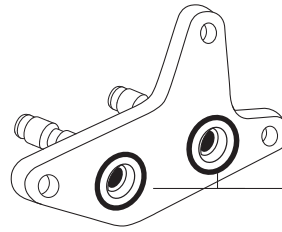

E101-1281  
**BA134**, Toyota truck and SUV  
transmission plate adaptor  
(bolts in place of cooler)

E100-6996  
O-Ring, Buna, -117 (.799 ID x .103)



E101-1335  
**BA135**, Audi, Hyundai, Kia female  
M18-1.5 transmission line  
adaptor, Mate BA53F

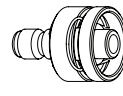

E101-1369  
**BA136**, Audi female QC  
transmission cooler adaptor,  
Mate BA137

E101-1397  
Retainer clip, R 3795



E101-1337  
**BA137**, Audi male QC  
transmission cooler adaptor,  
Mate BA136

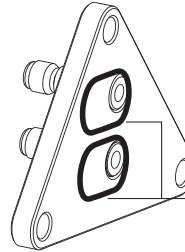

E101-1346  
**BA138**, Mini, CDJR transmission  
cooler plate adaptor  
(bolts in place of cooler)

E101-1407  
O-Ring, Buna, -120  
(.987 ID x .103)

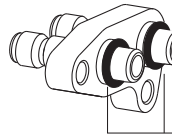

E101-1552  
**BA139**, Volvo EU  
transmission adaptor

E100-7002  
O-Ring, Buna, -111  
(.424 ID x .103)

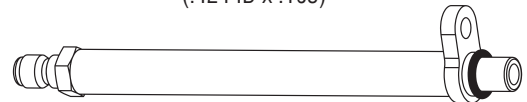

E101-1489  
**BA140**, Land Rover, Jaguar  
male transmission adaptor  
(requires two for service)

E100-7002  
O-Ring, Buna, -111  
(.424 ID x .103)

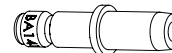

E101-1814  
**BA141**, Land Rover, Jaguar 1/2 spike  
QC transmission adaptor,  
Mate BA79



*continued on next page*

# Transmission Service Adaptors *continued*

For use with all BG transmission machines

**RED** characters in part numbers are marked on adaptors

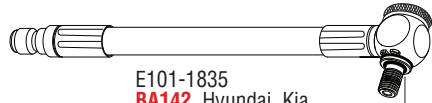

E101-1835  
**BA142**, Hyundai, Kia, Genesis 90° swivel M8-1.25 transmission adaptor

E100-7018  
O-Ring, Buna, -010 (.239 ID x .379)

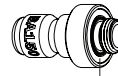

E101-2700  
**BA150**, GM 1/8 NPT universal THD

E100-3921  
O-Ring, Buna -013 (0.426 ID x .070)

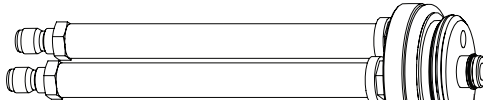

E101-1958  
**BA144**, Mercedes DCT filter adaptor (screws in place of the filter and housing)

E101-2064  
O-Ring, Buna, -329 (1.975 ID .210)

E100-7002  
O-Ring, Buna, -111 (.424 ID X .103)

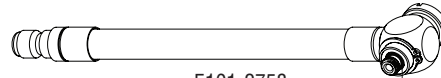

E101-2758  
**BA151**, Land Rover 90° swivel M8-1.0 transmission adaptor

E100-3922  
O-Ring, Buna -013 (0.426 ID .070),

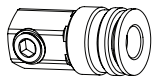

E101-1932  
**BA145**, Transmission block off adaptor

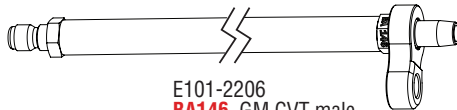

E101-2206  
**BA146**, GM CVT male 2019 and newer transmission adaptor, Mate BA147

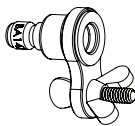

E101-2212  
**BA147**, GM CVT female 2019 and newer transmission adaptor, Mate BA146

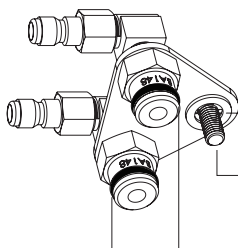

E101-2410  
**BA148**, Ford 10-speed transmission adaptor (bolts in place of cooler)

E100-6270  
Nylon captive washer

E101-2416  
M8-1.25 x 20 mm flanged bolt, Steel, zinc

E100-3910  
O-Ring, Buna, -206 (0.484 ID x .139)



E101-3729  
**BA152**, BMW 18.4 mm transmission adaptor (bolts directly to transmission)

E100-7000  
O-Ring, Buna -113 (.549 ID x .103), 2 each

E101-3727  
HCS, flanged, M8-1.25 x 20 mm, zinc plated

E100-6270  
Self retaining washer, (0.290 ID x .065)

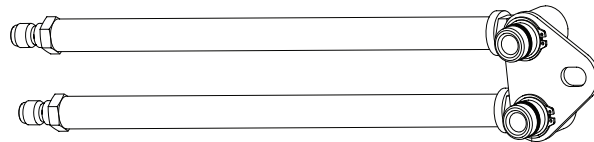

E101-3640  
**BA153**, BMW 16.8 mm transmission adaptor (bolts directly to transmission)

E100-7013  
O-Ring, Buna -115 (.551 ID x .070), 2 each

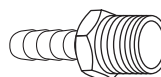

E100-3816  
Barb, 3/8" MNPT x 1/4" hose barb, hex straight, brass





# Light Duty Transmission Adaptor Set

PN E100-1322

For use with BG PXT<sup>®</sup>2, PXT<sup>®</sup> and PF5H0

**RED** characters in part numbers are marked on adaptors

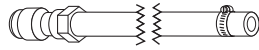

E100-1621  
**BA02**, 1/4 open hose transmission adaptor, Mate BA03



E100-1619  
**BA03**, 1/4 & 5/16 barb transmission adaptor, Mate BA02, BA04

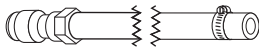

E100-1618  
**BA04**, 5/16 open hose transmission adaptor, Mate BA03



E100-1616  
**BA06**, 3/8 open hose transmission adaptor, Mate BA07

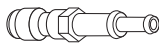

E100-1612  
**BA07**, 3/8 & 1/2 barb transmission adaptor, Mate BA06, BA08



E100-1611  
**BA08**, 1/2 open hose transmission adaptor, Mate BA07



E100-1558  
**BA11**, GM 5/16 male inverted flare 1/2-20 transmission adaptor, Mate BA12



E100-1536  
**BA12**, GM 5/16 female inverted flare 1/2-20 transmission adaptor, Mate BA11

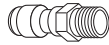

E100-1528  
**BA15**, Jeep, GM 3/8 male inverted flare 5/8-18 transmission adaptor, Mate BA22

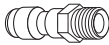

E100-1527  
**BA16**, GM 1/2 male inverted flare 3/4-18 transmission adaptor, Mate BA37

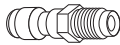

E100-1526  
**BA17**, Ford 3/8 male long inverted flare 5/8-18 transmission adaptor, Mate BA32

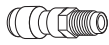

E100-1525  
**BA18**, Ford 5/16 male long inverted flare 1/2-20 transmission adaptor, Mate BA31

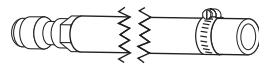

E100-1520  
**BA20**, 3/4 open hose transmission adaptor

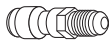

E100-1518  
**BA21**, GM 5/16 male JIC 1/2-20 transmission adaptor, Mate BA23

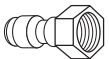

E100-1517  
**BA22**, Jeep, GM 3/8 female inverted flare 5/8-18 transmission adaptor, Mate BA15



E100-1516  
**BA23**, GM 5/16 female JIC 1/2-20 transmission adaptor, Mate BA21



E100-1515  
**BA24**, 7/16 inverted flare 11/16-18 transmission adaptor, Mate BA38



E100-1514  
**BA25**, Ford, CDJR 3/8 male spike QC transmission adaptor, Mate BA72



E100-1513  
**BA26**, CDJR 1/2 male spike QC transmission adaptor, Mate BA79



E100-1512  
**BA27**, Ford 5/16 spike QC transmission adaptor, Mate BA80



E100-1511  
**BA28**, GM, CDJR, Mercedes 3/8 male QC transmission adaptor, Mate BA72

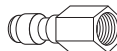

E100-1501  
**BA31**, Ford 5/16 female long inverted flare 1/2-20 transmission adaptor, Mate BA18

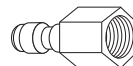

E100-1498  
**BA32**, Ford 3/8 female long inverted flare 5/8-18 transmission adaptor, Mate BA17

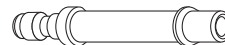

E100-1495  
**BA33**, GM, Ford, Mercedes 1/2 male QC transmission adaptor, Mate BA79



E100-1486  
**BA37**, GM 1/2 female inverted flare 3/4 -18 transmission adaptor, Mate BA16



E100-1483  
**BA38**, 7/16 female inverted flare 11/16 -18 transmission adaptor, Mate BA24

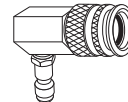

E100-1472  
**BA42**, 90° QC transmission adaptor

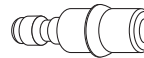

E100-1470  
**BA43**, GM 5/8 QC male transmission adaptor, Mate BA73

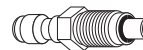

E100-1466  
**BA45**, CDJR male 5/8 -18 transmission adaptor, Mate BA77

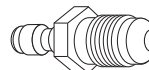

E100-1462  
**BA48**, CDJR male 11/16 -16 transmission adaptor, Mate BA49

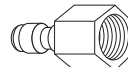

E100-1459  
**BA49**, CDJR female 11/16 -16 transmission adaptor, Mate BA48

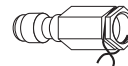

E100-1393  
**BA72**, GM, CDJR, Mercedes 3/8 female QC transmission adaptor, Mate BA25, BA28, BA113

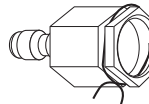

E100-1386  
**BA73**, GM 5/8 female QC transmission adaptor, Mate BA43

*continued on next page*



# Light Duty Transmission Adaptor Set

PN E100-1322 *continued*

For use with BG PXT<sup>®</sup>2, PXT<sup>®</sup>, and PF5H0

**RED** characters in part numbers are marked on adaptors

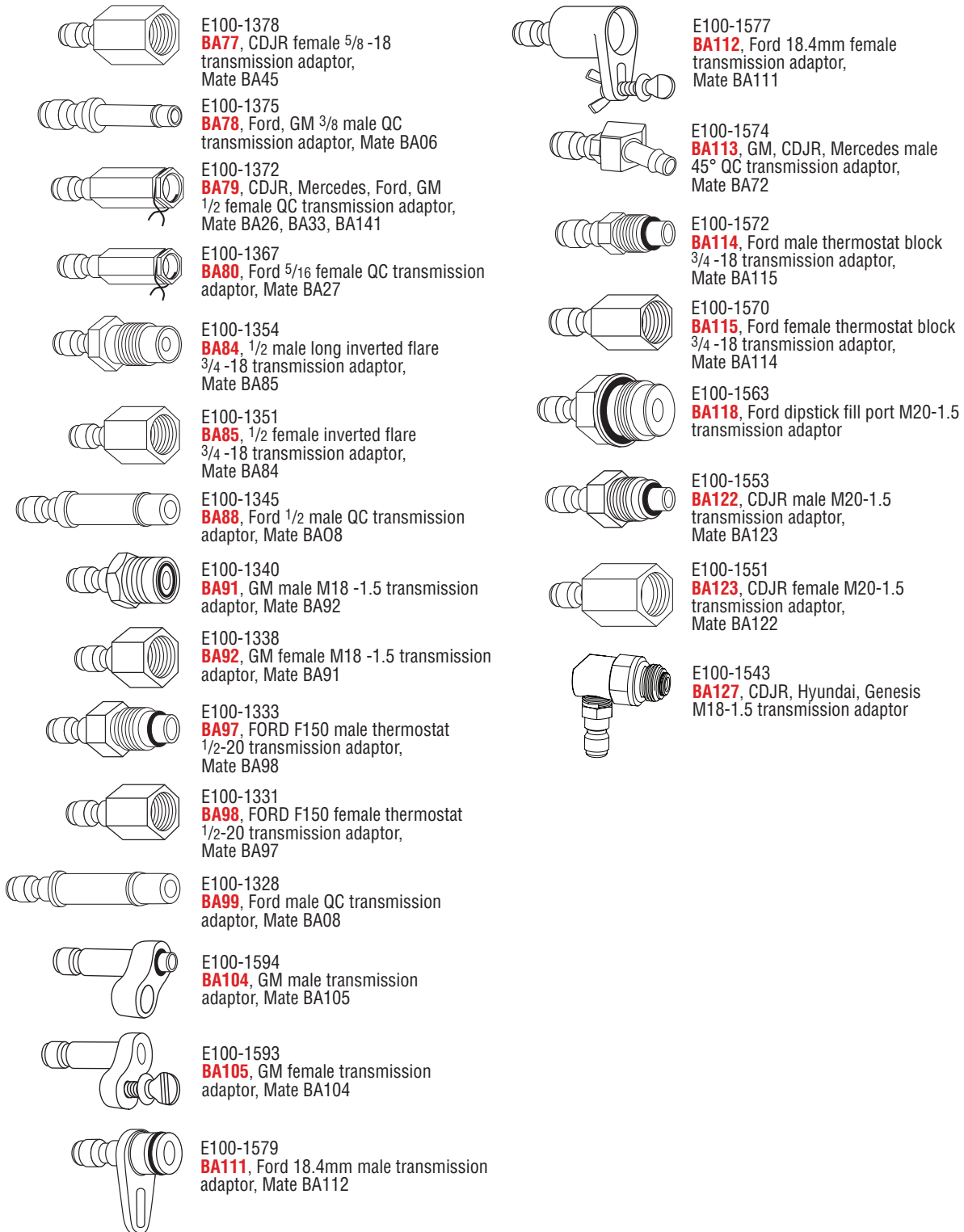

# European Transmission Adaptor Set

PN E100-1325

For use with BG PXT<sup>®</sup>2, PXT<sup>®</sup> and PF5H0

**RED** characters in part numbers are marked on adaptors

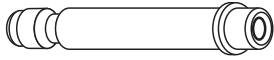

E100-1456  
**BA50**, BMW 12mm male spike QC transmission cooler adaptor, Mate BA50F



E100-1436  
**BA55C**, BA55 retaining clip

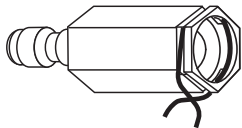

E100-1454  
**BA50F**, BMW 12mm female QC transmission cooler adaptor, Mate BA50

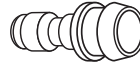

E100-1434  
**BA55F**, Volvo female transmission adaptor, Mate BA55

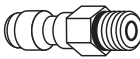

E100-1452  
**BA51**, Saab male M14-1.5mm transmission adaptor, Mate BA51F

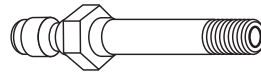

E100-1433  
**BA56**, VW, Audi single flange bolt transmission adaptor, (service requires 2)

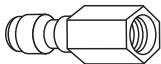

E100-1451  
**BA51F**, Saab, Land Rover female M14-1.5mm transmission adaptor, Mate BA51

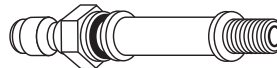

E100-1432  
**BA57**, VW, Audi double flange bolt transmission adaptor, (service requires 2)

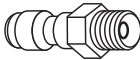

E100-1449  
**BA52**, BMW, Mercedes male flare M16-1.5 transmission adaptor, Mate BA52F

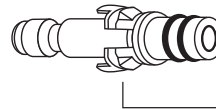

E100-1431  
**BA58**, Volvo male transmission adaptor with plastic clip, Mate BA58F

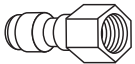

E100-1488  
**BA52F**, BMW, Mercedes female flare M16-1.5 transmission adaptor, Mate BA52

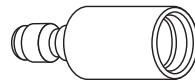

E100-1428  
**BA58F**, Volvo female transmission adaptor, Mate BA58

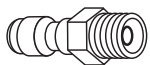

E100-1445  
**BA53**, BMW, Audi male flare M18-1.5 transmission adaptor, Mate BA53F

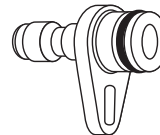

E100-1426  
**BA59**, Audi, VW, Porsche, BMW 16.4mm male transmission adaptor, Mate BA59F

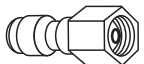

E100-1444  
**BA53F**, BMW, Audi female flare M18-1.5 transmission adaptor, Mate BA53, BA135

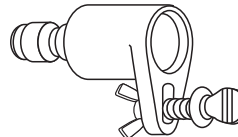

E100-1425  
**BA59F**, Audi, VW, Porsche, BMW 16.4mm female transmission adaptor, Mate BA59

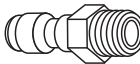

E100-1441  
**BA54**, BMW male O-ring M18-1.5 transmission adaptor, Mate BA54F



E100-1423  
**BA60**, Mercedes male QC transmission adaptor, Mate BA60F

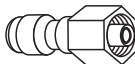

E100-1440  
**BA54F**, BMW female O-ring M18-1.5 transmission adaptor, Mate BA54

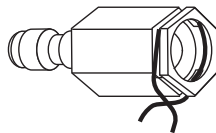

E100-1422  
**BA60F**, Mercedes female QC transmission adaptor, Mate BA60



E100-1437  
**BA55**, Volvo male transmission adaptor, Mate BA55F

*continued on next page*



# European Transmission Adaptor Set

PN E100-1325 *continued*

For use with BG PXT<sup>®</sup>2, PXT<sup>®</sup> and PF5H0

**RED** characters in part numbers are marked on adaptors

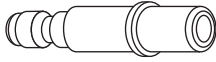

E100-1421  
**BA61**, BMW, Land Rover  
14mm male QC transmission  
adaptor, Mate BA61F

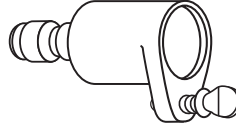

E100-1555  
**BA121**, BMW 18.9mm female  
transmission adaptor,  
Mate BA120

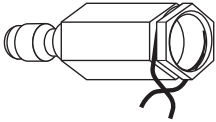

E100-1420  
**BA61F**, BMW, Land Rover  
14mm female QC transmission  
adaptor, Mate BA61

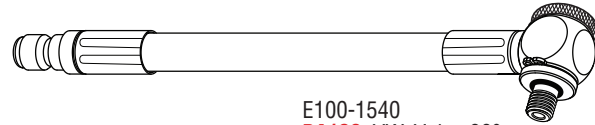

E100-1540  
**BA128**, VW, Volvo 90°  
swivel <sup>5</sup>/<sub>16</sub>-24  
transmission adaptor



E100-1405  
**BA66**, BMW 14.3mm male  
transmission adaptor,  
Mate BA66F

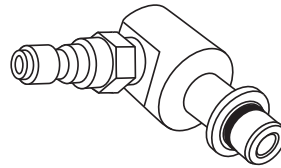

E100-1538  
**BA129**, BMW 6-speed diesel  
transmission adaptor

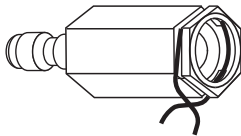

E100-1404  
**BA66F**, BMW 14.3mm female  
transmission adaptor,  
Mate BA66

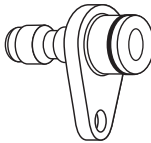

E100-1584  
**BA108**, VW 16.4mm male  
transmission adaptor,  
Mate BA109

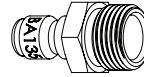

E101-1335  
**BA135**, Audi, Hyundai, Kia female  
M18-1.5 transmission line  
adaptor, Mate BA53F

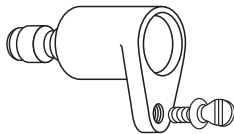

E100-1582  
**BA109**, VW 16.4mm female  
transmission adaptor,  
Mate BA108

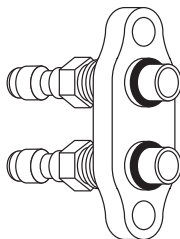

E100-1566  
**BA117**, Volvo US  
transmission adaptor

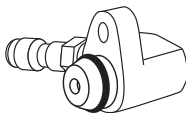

E100-1557  
**BA120**, BMW 18.9mm  
male transmission adaptor,  
Mate BA121



# European Transmission Optional Adaptors

For use with BG PXT<sup>®</sup>2, PXT<sup>®</sup>, and PF5H0

**RED** characters in part numbers are marked on adaptors

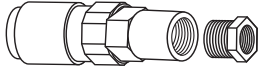

E100-1523  
**BA19**, PF5 recharge adaptor

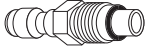

E100-1468  
**BA44**, Jaguar, Land Rover male  
M18-1.5 transmission adaptor,  
Mate BA76



E100-1464  
**BA46**, Honda, Acura female banjo  
M12-1.25 transmission adaptor,  
Mate BA47

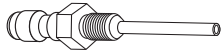

E100-1463  
**BA47**, Honda, Acura male banjo  
M12-1.25 transmission adaptor,  
Mate BA46

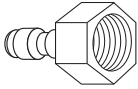

E100-1395  
**BA70**, Land Rover female M20-1.5  
transmission adaptor, Mate BA71

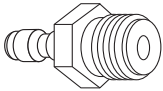

E100-1394  
**BA71**, Land Rover, Honda male M20-1.5  
transmission adaptor, Mate BA70

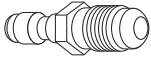

E100-1381  
**BA74**, Isuzu Cabover male M16-1.5  
transmission adaptor, Mate BA75

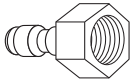

E100-1380  
**BA75**, Isuzu Cabover female M16-1.5  
transmission adaptor, Mate BA74

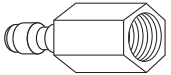

E100-1379  
**BA76**, Jaguar, Land Rover female M18-1.5  
transmission adaptor, Mate BA44

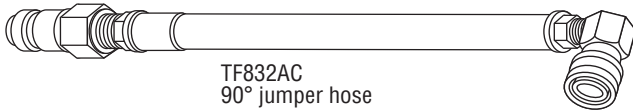

TF832AC  
90° jumper hose

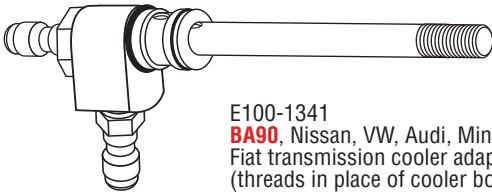

E100-1341  
**BA90**, Nissan, VW, Audi, Mini,  
Fiat transmission cooler adaptor  
(threads in place of cooler bolt)

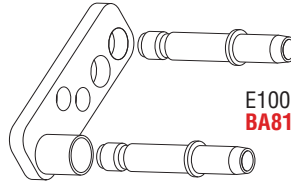

E100-1364  
**BA81**, Saturn transmission adaptor

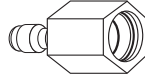

E100-1360  
**BA82**, Allison, Chevy Workhorse female  
QC transmission adaptor, Mate BA83

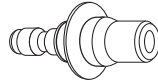

E100-1358  
**BA83**, Allison, Chevy Workhorse male  
QC transmission adaptor, Mate BA82

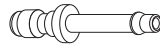

E100-1348  
**BA86**, GM, CDJR, Mercedes long  
male QC transmission adaptor,  
Mate BA28

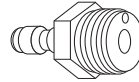

E100-1347  
**BA87**, used oil drum plug  
adaptor 3/4-14

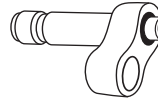

E100-1594  
**BA104**, GM male transmission  
adaptor, Mate BA105

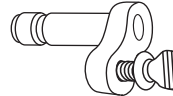

E100-1593  
**BA105**, GM female transmission  
adaptor, Mate BA104



E101-1054  
**BA132**, Audi, Porsche, Hyundai,  
Kia, Genesis 12mm male  
transmission adaptor,  
Mate BA08

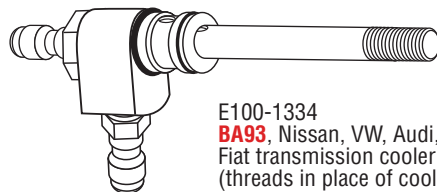

E100-1334  
**BA93**, Nissan, VW, Audi, Mini,  
Fiat transmission cooler adaptor  
(threads in place of cooler bolt)



# European Transmission Adaptor Set (V2)

PN E100-1608

For use with BG PXT<sup>®</sup>2, PXT,<sup>®</sup> and PF5H0

**RED** characters in part numbers are marked on adaptors

Set includes European Transmission Adaptor Set, PN E100-1325 and adaptors listed below

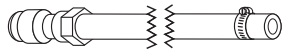

E100-1621  
**BA02**, 1/4 open hose transmission adaptor, Mate BA03



E100-1619  
**BA03**, 1/4 & 5/16 barb transmission adaptor, Mate BA02, BA04



E100-1618  
**BA04**, 5/16 open hose transmission adaptor, Mate BA03



E100-1616  
**BA06**, 3/8 open hose transmission adaptor, Mate BA07

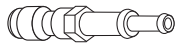

E100-1612  
**BA07**, 3/8 & 1/2 barb transmission adaptor, Mate BA06, BA08

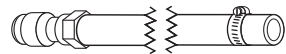

E100-1611  
**BA08**, 1/2 open hose transmission adaptor, Mate BA07



E100-1520  
**BA20**, 3/4 open hose transmission adaptor

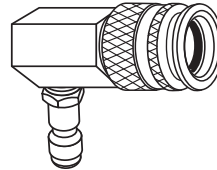

E100-1472  
**BA42**, 90° QC transmission adaptor

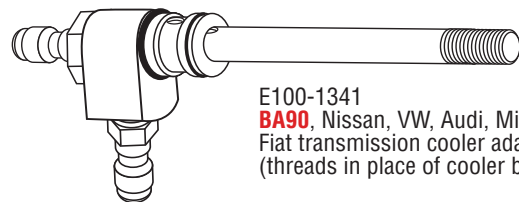

E100-1341  
**BA90**, Nissan, VW, Audi, Mini, Fiat transmission cooler adaptor (threads in place of cooler bolt)

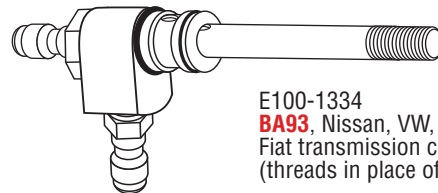

E100-1334  
**BA93**, Nissan, VW, Audi, Mini, Fiat transmission cooler adaptor (threads in place of cooler bolt)



# Ultimate Transmission Adaptor Set

PN E100-1521

For use with BG PXT<sup>®</sup>2, PXT<sup>®</sup> and PF5H0

**RED** characters in part numbers are marked on adaptors

Set includes Light Duty Transmission Adaptor Set, PN E100-1322, European Transmission Adaptor Set, PN E100-1325 and adaptors listed below

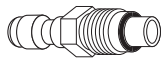

E100-1468  
**BA44**, Jaguar, Land Rover male  
M18-1.5 transmission adaptor,  
Mate BA76

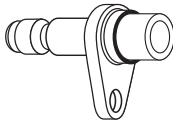

E100-1419  
**BA62**, Volvo 12mm male  
transmission adaptor,  
Mate BA62F

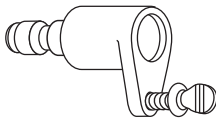

E100-1418  
**BA62F**, Volvo 12mm female  
transmission adaptor,  
Mate BA62

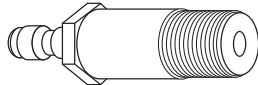

E100-1417  
**BA63**, Citroen, Peugeot  
transmission cooler adaptor

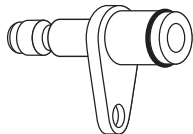

E100-1403  
**BA67**, Audi 14.8mm male  
transmission adaptor,  
Mate BA67F

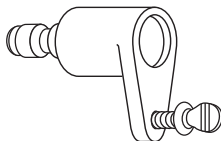

E100-1400  
**BA67F**, Audi 14.8mm female  
transmission adaptor,  
Mate BA67

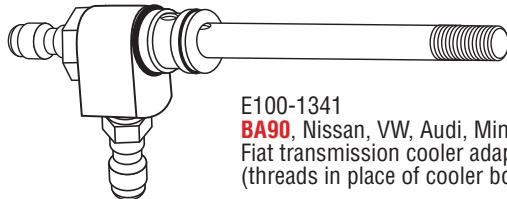

E100-1341  
**BA90**, Nissan, VW, Audi, Mini,  
Fiat transmission cooler adaptor  
(threads in place of cooler bolt)

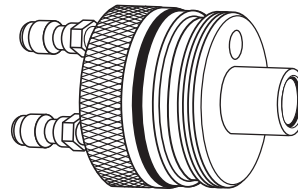

E100-1398  
**BA68**, VW, Audi DSG  
transmission adaptor,  
(spins on in place of  
the filter housing)

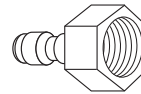

E100-1395  
**BA70**, Land Rover female M20-1.5  
transmission adaptor, Mate BA71

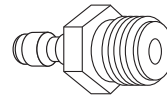

E100-1394  
**BA71**, Land Rover, Honda male  
M20-1.5 transmission adaptor,  
Mate BA70

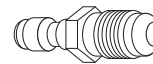

E100-1381  
**BA74**, Isuzu Cabover male  
M16-1.5 transmission adaptor,  
Mate BA75

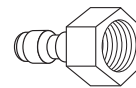

E100-1380  
**BA75**, Isuzu Cabover female  
M16-1.5 transmission adaptor,  
Mate BA74

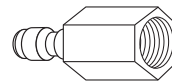

E100-1379  
**BA76**, Jaguar, Land Rover female  
M18-1.5 transmission adaptor,  
Mate BA44

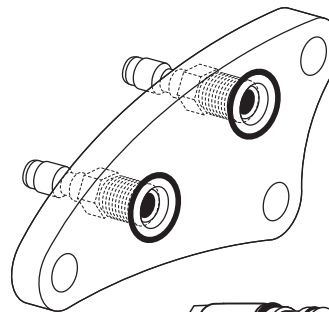

E100-1569  
**BA116**, Mazda transmission  
plate adaptor  
(bolts in place of cooler)

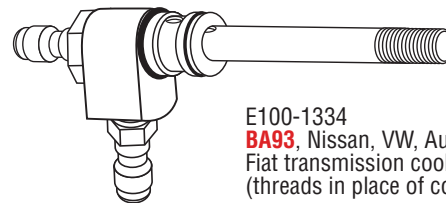

E100-1334  
**BA93**, Nissan, VW, Audi, Mini,  
Fiat transmission cooler adaptor  
(threads in place of cooler bolt)



# Acura Transmission Adaptor Set

PN E101-2560

For use with BG PXT<sup>®</sup>2, PXT<sup>®</sup> and PF5H0

**RED** characters in part numbers are marked on adaptors

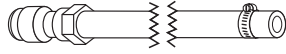

E100-1621  
**BA02**, 1/4 open hose  
transmission adaptor, Mate BA03

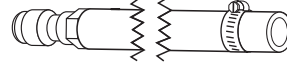

E100-1520  
**BA20**, 3/4 open hose  
transmission adaptor



E100-1619  
**BA03**, 1/4 & 5/16 barb transmission  
adaptor, Mate BA02, BA04

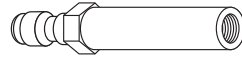

E100-1464  
**BA46**, Honda, Acura female banjo  
M12-1.25 transmission adaptor,  
Mate BA47



E100-1618  
**BA04**, 5/16 open hose  
transmission adaptor, Mate BA03

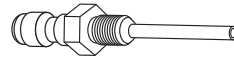

E100-1463  
**BA47**, Honda, Acura male banjo  
M12-1.25 transmission adaptor,  
Mate BA46

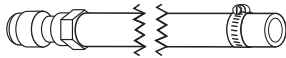

E100-1616  
**BA06**, 3/8 open hose transmission  
adaptor, Mate BA07

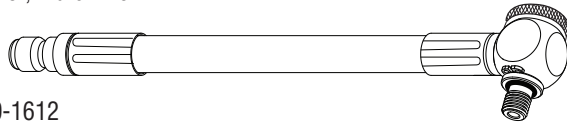

E100-1550  
**BA124**, Honda, Acura,  
Hyundai, Kia M10-1.25 90°  
swivel transmission adaptor

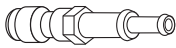

E100-1612  
**BA07**, 3/8 & 1/2 barb transmission  
adaptor, Mate BA06, BA08

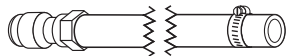

E100-1611  
**BA08**, 1/2 open hose transmission  
adaptor, Mate BA07





# Audi Transmission Adaptor Set

PN E101-2561

For use with BG PXT<sup>®</sup>2, PXT<sup>®</sup> and PF5H0

**RED** characters in part numbers are marked on adaptors

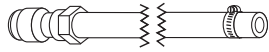

E100-1621  
**BA02**, 1/4 open hose transmission adaptor, Mate BA03



E100-1619  
**BA03**, 1/4 & 5/16 barb transmission adaptor, Mate BA02, BA04

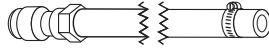

E100-1618  
**BA04**, 5/16 open hose transmission adaptor, Mate BA03

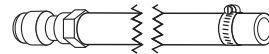

E100-1616  
**BA06**, 3/8 open hose transmission adaptor, Mate BA07

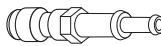

E100-1612  
**BA07**, 3/8 & 1/2 barb transmission adaptor, Mate BA06, BA08



E100-1611  
**BA08**, 1/2 open hose transmission adaptor, Mate BA07

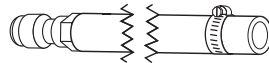

E100-1520  
**BA20**, 3/4 open hose transmission adaptor

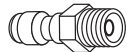

E100-1445  
**BA53**, BMW, Audi male flare M18-1.5 transmission adaptor, Mate BA53F

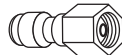

E100-1444  
**BA53F**, BMW, Audi female flare M18-1.5 transmission adaptor, Mate BA53, BA135

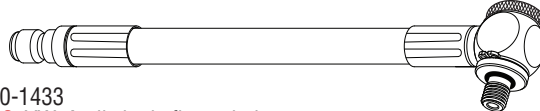

E100-1433  
**BA56**, VW, Audi single flange bolt transmission adaptor, (service requires 2)

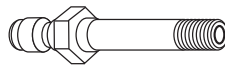

E100-1432  
**BA57**, VW, Audi double flange bolt transmission adaptor, (service requires 2)

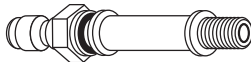

E100-1426  
**BA59**, Audi, VW, Porsche, BMW 16.4mm male transmission adaptor, Mate BA59F

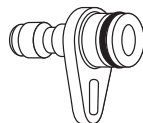

E100-1425  
**BA59F**, Audi, VW, Porsche, BMW 16.4mm female transmission adaptor, Mate BA59

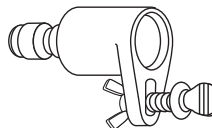

E100-1341  
**BA90**, Nissan, VW, Audi, Mini, Fiat transmission cooler adaptor (threads in place of cooler bolt)

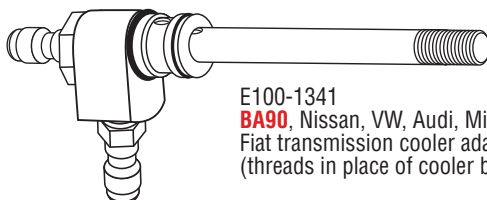

E100-1403  
**BA67**, Audi 14.8mm male transmission adaptor, Mate BA67F

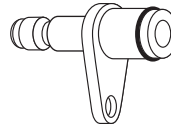

E100-1400  
**BA67F**, Audi 14.8mm female transmission adaptor, Mate BA67

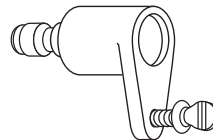

E100-1398  
**BA68**, VW, Audi DSG transmission adaptor, (spins on in place of the filter housing)

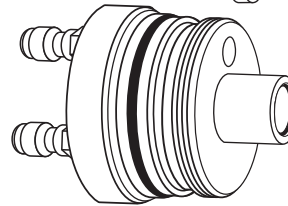

E100-1584  
**BA108**, VW 16.4mm male transmission adaptor, Mate BA109

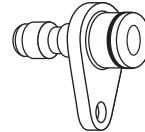

E100-1582  
**BA109**, VW 16.4mm female transmission adaptor, Mate BA108

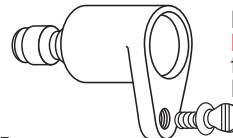

E100-1540  
**BA128**, VW, Volvo 90° swivel 5/16-24 transmission adaptor

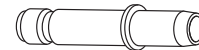

E101-1054  
**BA132**, Audi, Porsche, Hyundai, Kia, Genesis 12mm male transmission adaptor, Mate BA08



E101-1335  
**BA135**, Audi, Hyundai, Kia female M18-1.5 transmission line adaptor, Mate BA53F

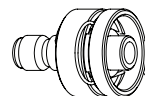

E101-1369  
**BA136**, Audi female QC transmission cooler adaptor, Mate BA137



E101-1337  
**BA137**, Audi male QC transmission cooler adaptor, Mate BA136

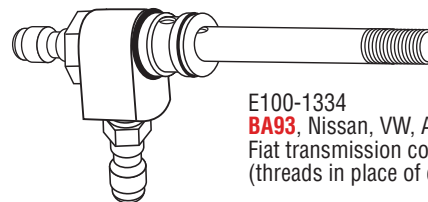

E100-1334  
**BA93**, Nissan, VW, Audi, Mini, Fiat transmission cooler adaptor (threads in place of cooler bolt)



# BMW Transmission Adaptor Set

PN E101-2562

For use with BG PXT<sup>®</sup>2, PXT<sup>®</sup> and PF5H0

**RED** characters in part numbers are marked on adaptors

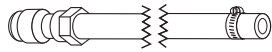

E100-1621  
**BA02**, 1/4 open hose  
transmission adaptor,  
Mate BA03



E100-1619  
**BA03**, 1/4 & 5/16 barb  
transmission adaptor,  
Mate BA02, BA04

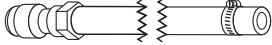

E100-1618  
**BA04**, 5/16 open hose  
transmission adaptor, Mate BA03



E100-1616  
**BA06**, 3/8 open hose transmission  
adaptor, Mate BA07

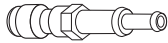

E100-1612  
**BA07**, 3/8 & 1/2 barb transmission  
adaptor, Mate BA06, BA08



E100-1611  
**BA08**, 1/2 open hose transmission  
adaptor, Mate BA07



E100-1520  
**BA20**, 3/4 open hose  
transmission adaptor



E100-1456  
**BA50**, BMW 12mm male spike QC  
transmission cooler adaptor,  
Mate BA50F

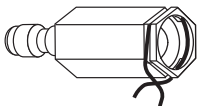

E100-1454  
**BA50F**, BMW 12mm female QC  
transmission cooler adaptor,  
Mate BA50



E100-1449  
**BA52**, BMW, Mercedes male flare  
M16-1.5 transmission adaptor,  
Mate BA52F

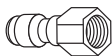

E100-1488  
**BA52F**, BMW, Mercedes female flare  
M16-1.5 transmission adaptor,  
Mate BA52

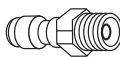

E100-1445  
**BA53**, BMW, Audi male flare  
M18-1.5 transmission adaptor,  
Mate BA53F

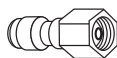

E100-1444  
**BA53F**, BMW, Audi female flare  
M18-1.5 transmission adaptor,  
Mate BA53, BA135

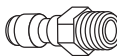

E100-1441  
**BA54**, BMW male O-ring  
M18-1.5 transmission adaptor,  
Mate BA54F

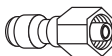

E100-1440  
**BA54F**, BMW female O-ring  
M18-1.5 transmission adaptor,  
Mate BA54



E100-1421  
**BA61**, BMW, Land Rover  
14mm male QC transmission  
adaptor, Mate BA61F

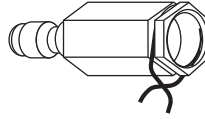

E100-1420  
**BA61F**, BMW, Land Rover  
14mm female QC transmission  
adaptor, Mate BA61



E100-1405  
**BA66**, BMW 14.3mm male  
transmission adaptor, Mate BA66F

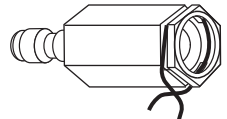

E100-1404  
**BA66F**, BMW 14.3mm female  
transmission adaptor, Mate BA66

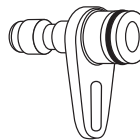

E100-1579  
**BA111**, Ford 18.4mm male  
transmission adaptor,  
Mate BA112

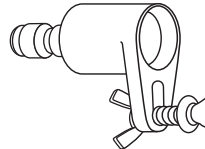

E100-1577  
**BA112**, Ford 18.4mm female  
transmission adaptor,  
Mate BA111

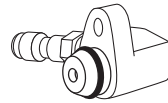

E100-1557  
**BA120**, BMW 18.9mm  
male transmission adaptor,  
Mate BA121

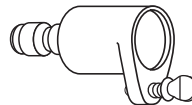

E100-1555  
**BA121**, BMW 18.9mm female  
transmission adaptor,  
Mate BA120

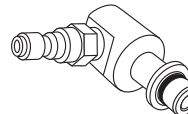

E100-1538  
**BA129**, BMW 6-speed diesel  
transmission adaptor

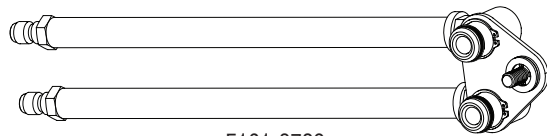

E101-3729  
**BA152**, BMW 18.4mm transmission  
adaptor (bolts directly to transmission)

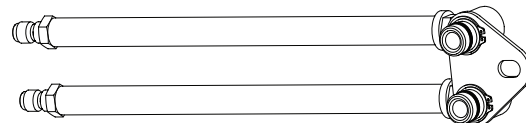

E101-3640  
**BA153**, BMW 16.8mm transmission  
adaptor (bolts directly to transmission)



# Fiat Transmission Adaptor Set

PN E101-2563

For use with BG PXT<sup>®</sup>2, PXT<sup>®</sup>, and PF5H0

**RED** characters in part numbers are marked on adaptors

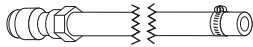

E100-1621  
**BA02**, 1/4 open hose  
transmission adaptor, Mate BA03



E100-1619  
**BA03**, 1/4 & 5/16 barb  
transmission adaptor,  
Mate BA02, BA04



E100-1618  
**BA04**, 5/16 open hose  
transmission adaptor,  
Mate BA03



E100-1616  
**BA06**, 3/8 open hose  
transmission adaptor,  
Mate BA07

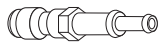

E100-1612  
**BA07**, 3/8 & 1/2 barb  
transmission adaptor,  
Mate BA06, BA08



E100-1611  
**BA08**, 1/2 open hose  
transmission adaptor, Mate BA07



E100-1520  
**BA20**, 3/4 open hose  
transmission adaptor



E100-1514  
**BA25**, Ford, CDJR 3/8 male  
spike QC transmission adaptor,  
Mate BA72

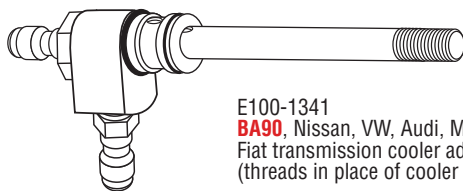

E100-1341  
**BA90**, Nissan, VW, Audi, Mini,  
Fiat transmission cooler adaptor  
(threads in place of cooler bolt)

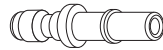

E100-1513  
**BA26**, CDJR 1/2 male spike QC  
transmission adaptor, Mate BA79

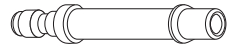

E100-1495  
**BA33**, GM, Ford, Mercedes 1/2 male QC  
transmission adaptor, Mate BA79

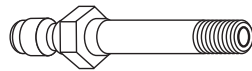

E100-1433  
**BA56**, VW, Audi single flange bolt  
transmission adaptor,  
(service requires 2)

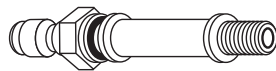

E100-1432  
**BA57**, VW, Audi double flange bolt  
transmission adaptor,  
(service requires 2)

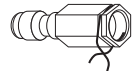

E100-1393  
**BA72**, GM, CDJR, Mercedes 3/8  
female QC transmission adaptor,  
Mate BA25, BA28, BA113

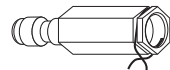

E100-1372  
**BA79**, CDJR, Mercedes, Ford, GM  
1/2 female QC transmission adaptor,  
Mate BA26, BA33, BA141

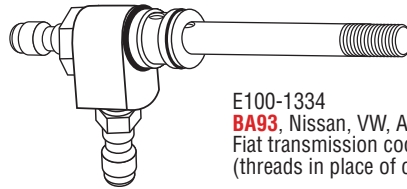

E100-1334  
**BA93**, Nissan, VW, Audi, Mini,  
Fiat transmission cooler adaptor  
(threads in place of cooler bolt)



# Ford Transmission Adaptor Set

PN E101-2564

For use with BG PXT<sup>®</sup>2, PXT<sup>®</sup>, and PF5H0

**RED** characters in part numbers are marked on adaptors

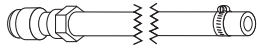

E100-1621  
**BA02**, 1/4 open hose transmission adaptor, Mate BA03



E100-1619  
**BA03**, 1/4 & 5/16 barb transmission adaptor, Mate BA02, BA04

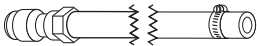

E100-1618  
**BA04**, 5/16 open hose transmission adaptor, Mate BA03



E100-1616  
**BA06**, 3/8 open hose transmission adaptor, Mate BA07

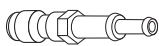

E100-1612  
**BA07**, 3/8 & 1/2 barb transmission adaptor, Mate BA06, BA08



E100-1588  
**BA107**, Nissan, Ford, CDJR pressure port M10-1.0 transmission adaptor



E100-1611  
**BA08**, 1/2 open hose transmission adaptor, Mate BA07

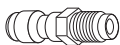

E100-1526  
**BA17**, Ford 3/8 male long inverted flare 5/8-18 transmission adaptor, Mate BA32

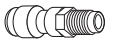

E100-1525  
**BA18**, Ford 5/16 male long inverted flare 1/2-20 transmission adaptor, Mate BA31

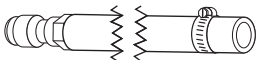

E100-1520  
**BA20**, 3/4 open hose transmission adaptor

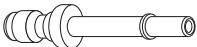

E100-1514  
**BA25**, Ford, CDJR 3/8 male spike QC transmission adaptor, Mate BA72

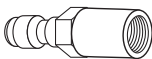

E100-1501  
**BA31**, Ford 5/16 female long inverted flare 1/2-20 transmission adaptor, Mate BA18

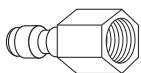

E100-1498  
**BA32**, Ford 3/8 female long inverted flare 5/8-18 transmission adaptor, Mate BA17

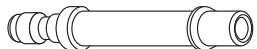

E100-1495  
**BA33**, GM, Ford, Mercedes 1/2 male QC transmission adaptor, Mate BA79



E100-1375  
**BA78**, Ford, GM 3/8 male QC transmission adaptor, Mate BA06

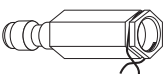

E100-1372  
**BA79**, CDJR, Mercedes, Ford, GM 1/2 female QC transmission adaptor, Mate BA26, BA33, BA141



E100-1345  
**BA88**, Ford 1/2 male QC transmission adaptor, Mate BA08

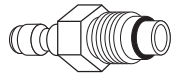

E100-1333  
**BA97**, FORD F150 male thermostat 1/2-20 transmission adaptor, Mate BA98

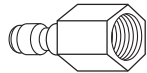

E100-1331  
**BA98**, FORD F150 female thermostat 1/2-20 transmission adaptor, Mate BA97



E100-1328  
**BA99**, Ford male QC transmission adaptor, Mate BA08



E100-1579  
**BA111**, Ford 18.4mm male transmission adaptor, Mate BA112

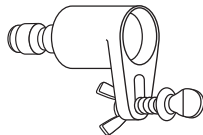

E100-1577  
**BA112**, Ford 18.4mm female transmission adaptor, Mate BA111

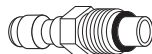

E100-1572  
**BA114**, Ford male thermostat block 3/4-18 transmission adaptor, Mate BA115

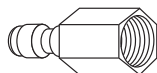

E100-1570  
**BA115**, Ford female thermostat block 3/4-18 transmission adaptor, Mate BA114

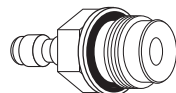

E100-1563  
**BA118**, Ford dipstick fill port M20-1.5 transmission adaptor

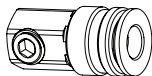

E101-1932  
**BA145**, Transmission block off adaptor

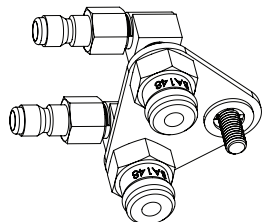

E101-2410  
**BA148**, Ford 10 speed transmission adaptor



# GM Transmission Adaptor Set

PN E101-2565

For use with BG PXT<sup>®</sup>2, PXT<sup>®</sup>, and PF5H0

**RED** characters in part numbers are marked on adaptors

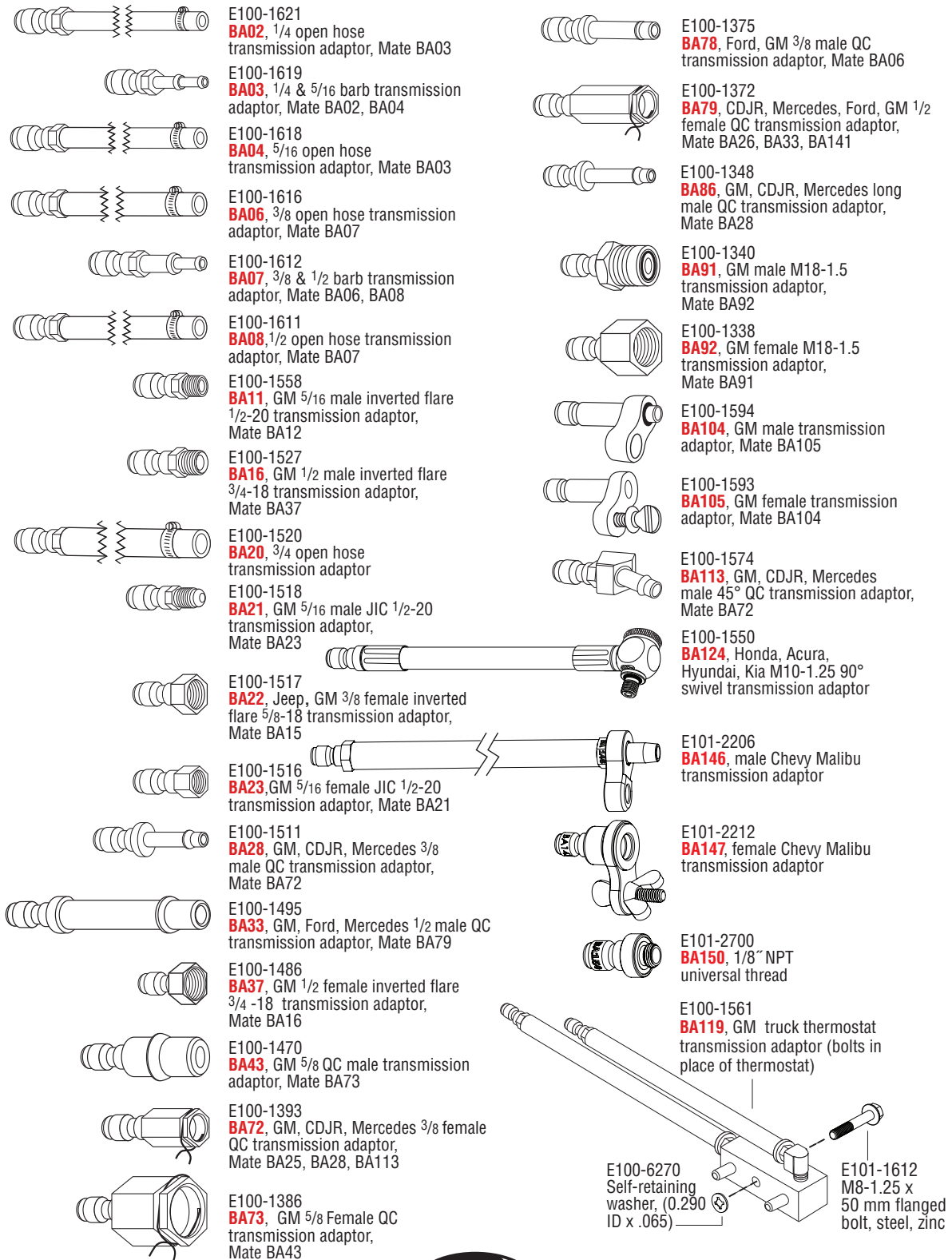

# Honda Transmission Adaptor Set

PN E101-2566

For use with BG PXT<sup>®</sup>2, PXT<sup>®</sup>, and PF5H0

**RED** characters in part numbers are marked on adaptors

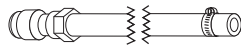

E100-1621  
**BA02**, 1/4 open hose  
transmission adaptor, Mate BA03



E100-1619  
**BA03**, 1/4 & 5/16 barb transmission  
adaptor, Mate BA02, BA04

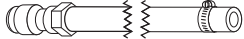

E100-1618  
**BA04**, 5/16 open hose  
transmission adaptor, Mate BA03



E100-1616  
**BA06**, 3/8 open hose transmission  
adaptor, Mate BA07



E100-1612  
**BA07**, 3/8 & 1/2 barb transmission  
adaptor, Mate BA06, BA08

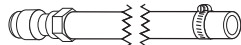

E100-1611  
**BA08**, 1/2 open hose transmission  
adaptor, Mate BA07

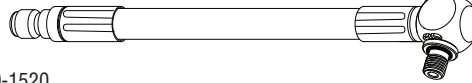

E100-1520  
**BA20**, 3/4 open hose  
transmission adaptor

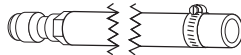

E100-1511  
**BA28**, GM, CDJR, Mercedes 3/8  
male QC transmission adaptor,  
Mate BA72

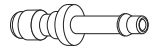

E100-1464  
**BA46**, Honda, Acura female banjo  
M12-1.25 transmission adaptor,  
Mate BA47

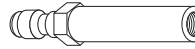

E100-1463  
**BA47**, Honda, Acura male banjo  
M12-1.25 transmission adaptor,  
Mate BA46

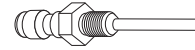

E100-1394  
**BA71**, Land Rover, Honda male M20-1.5  
transmission adaptor, Mate BA70

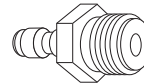

E100-1393  
**BA72**, GM, CDJR, Mercedes 3/8 female  
QC transmission adaptor,  
Mate BA25, BA28, BA113

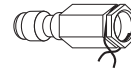

E100-1550  
**BA124**, Honda, Acura,  
Hyundai, Kia M10-1.25 90°  
swivel transmission adaptor

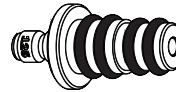

E100-1548  
**BA125**, Honda, Acura  
transmission fill plug adaptor



# Hyundai/Kia/Genesis Transmission Adaptor Set

PN E101-2567

For use with BG PXT<sup>®</sup>2, PXT<sup>®</sup> and PF5HO

**RED** characters in part numbers are marked on adaptors

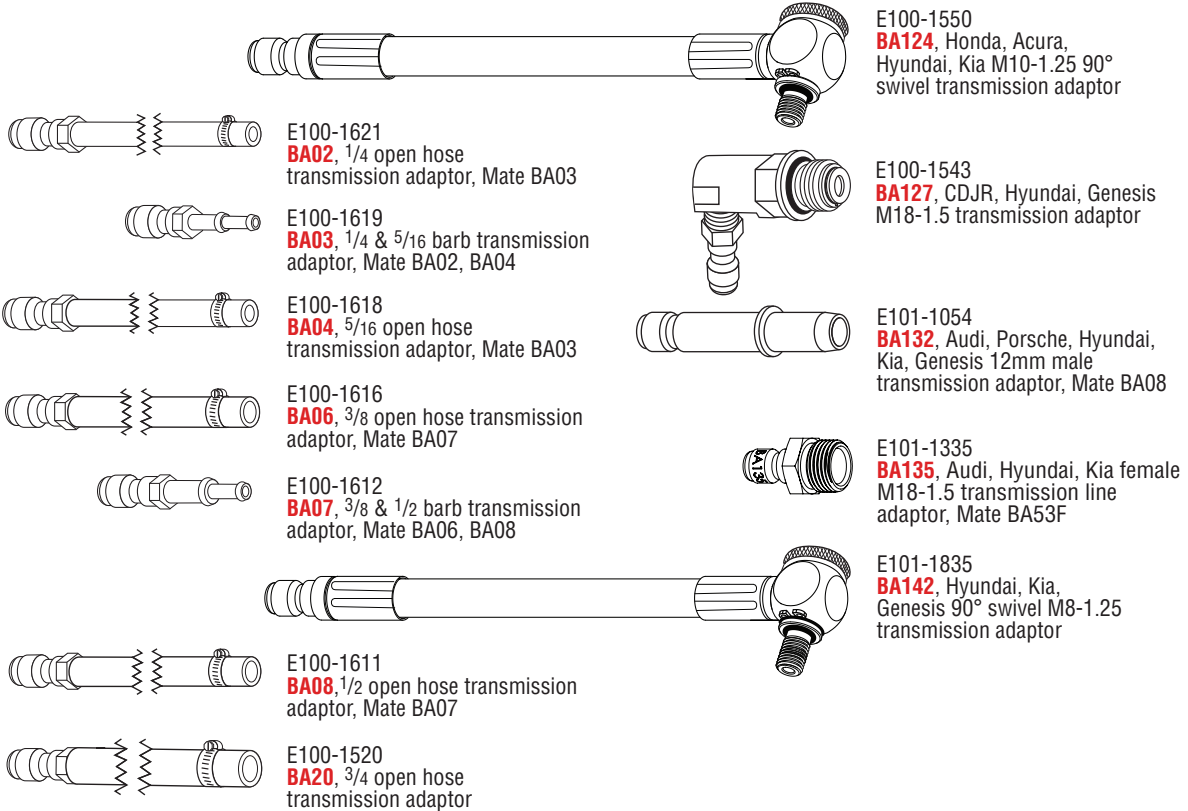

# Infiniti Transmission Adaptor Set

PN E101-2568

For use with BG PXT<sup>®</sup>2, PXT<sup>®</sup> and PF5H0

**RED** characters in part numbers are marked on adaptors

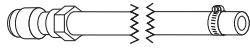

E100-1621  
**BA02**, 1/4 open hose  
transmission adaptor, Mate BA03



E100-1619  
**BA03**, 1/4 & 5/16 barb  
transmission adaptor,  
Mate BA02, BA04

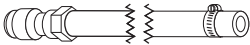

E100-1618  
**BA04**, 5/16 open hose  
transmission adaptor, Mate BA03

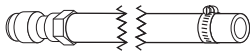

E100-1616  
**BA06**, 3/8 open hose transmission  
adaptor, Mate BA07



E100-1612  
**BA07**, 3/8 & 1/2 barb transmission  
adaptor, Mate BA06, BA08

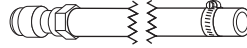

E100-1611  
**BA08**, 1/2 open hose transmission  
adaptor, Mate BA07



E100-1520  
**BA20**, 3/4 open hose  
transmission adaptor

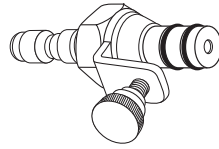

E100-1592  
**BA106**, Nissan CVT dip  
stick adaptor



E100-1588  
**BA107**, Nissan, Ford, CDJR pressure port  
M10-1.0 transmission adaptor

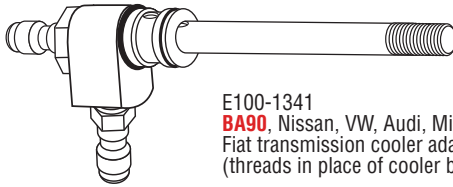

E100-1341  
**BA90**, Nissan, VW, Audi, Mini,  
Fiat transmission cooler adaptor  
(threads in place of cooler bolt)

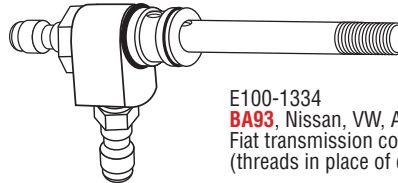

E100-1334  
**BA93**, Nissan, VW, Audi, Mini,  
Fiat transmission cooler adaptor  
(threads in place of cooler bolt)





# JLR Transmission Adaptor Set

PN E101-2569

For use with BG PXT<sup>®</sup>2, PXT<sup>®</sup> and PF5H0

**RED** characters in part numbers are marked on adaptors

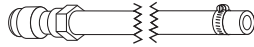

E100-1621  
**BA02**, 1/4 open hose  
transmission adaptor, Mate BA03



E100-1619  
**BA03**, 1/4 & 5/16 barb  
transmission adaptor,  
Mate BA02, BA04

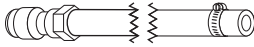

E100-1618  
**BA04**, 5/16 open hose  
transmission adaptor, Mate BA03



E100-1616  
**BA06**, 3/8 open hose transmission  
adaptor, Mate BA07

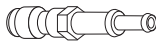

E100-1612  
**BA07**, 3/8 & 1/2 barb transmission  
adaptor, Mate BA06, BA08



E100-1611  
**BA08**, 1/2 open hose transmission  
adaptor, Mate BA07

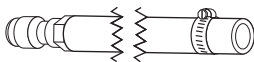

E100-1520  
**BA20**, 3/4 open hose  
transmission adaptor

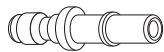

E100-1513  
**BA26**, CDJR 1/2 male spike QC  
transmission adaptor, Mate BA79

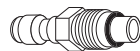

E100-1468  
**BA44**, Jaguar, Land Rover male  
M18-1.5 transmission adaptor,  
Mate BA76



E100-1421  
**BA61**, BMW, Land Rover  
14mm male QC transmission  
adaptor, Mate BA61F



E101-1489  
**BA140**, Land Rover, Jaguar  
male transmission adaptor  
(requires two for service)

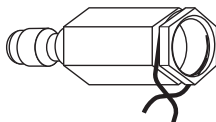

E100-1420  
**BA61F**, BMW, Land Rover  
14mm female QC transmission  
adaptor, Mate BA61

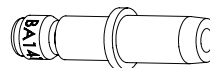

E101-1814  
**BA141**, Land Rover, Jaguar 1/2 spike  
QC transmission adaptor,  
Mate BA79

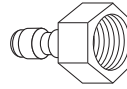

E100-1395  
**BA70**, Land Rover female M20-1.5  
transmission adaptor, Mate BA71

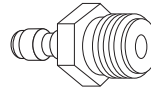

E100-1394  
**BA71**, Land Rover, Honda male M20-1.5  
transmission adaptor, Mate BA70

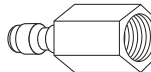

E100-1379  
**BA76**, Jaguar, Land Rover female M18-1.5  
transmission adaptor, Mate BA44

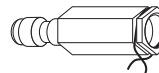

E100-1372  
**BA79**, CDJR, Mercedes, Ford, GM 1/2  
female QC transmission adaptor,  
Mate BA26, BA33, BA141

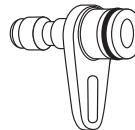

E100-1579  
**BA111**, Ford 18.4mm male  
transmission adaptor,  
Mate BA112

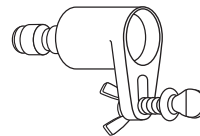

E100-1577  
**BA112**, Ford 18.4mm female  
transmission adaptor,  
Mate BA111

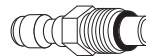

E100-1572  
**BA114**, Ford male thermostat block  
3/4-18 transmission adaptor,  
Mate BA115

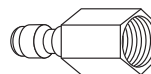

E100-1570  
**BA115**, Ford female thermostat block  
3/4-18 transmission adaptor,  
Mate BA114



# Lexus Transmission Adaptor Set

PN E101-2571

For use with BG PXT<sup>®</sup>2, PXT<sup>®</sup> and PF5H0

**RED** characters in part numbers are marked on adaptors

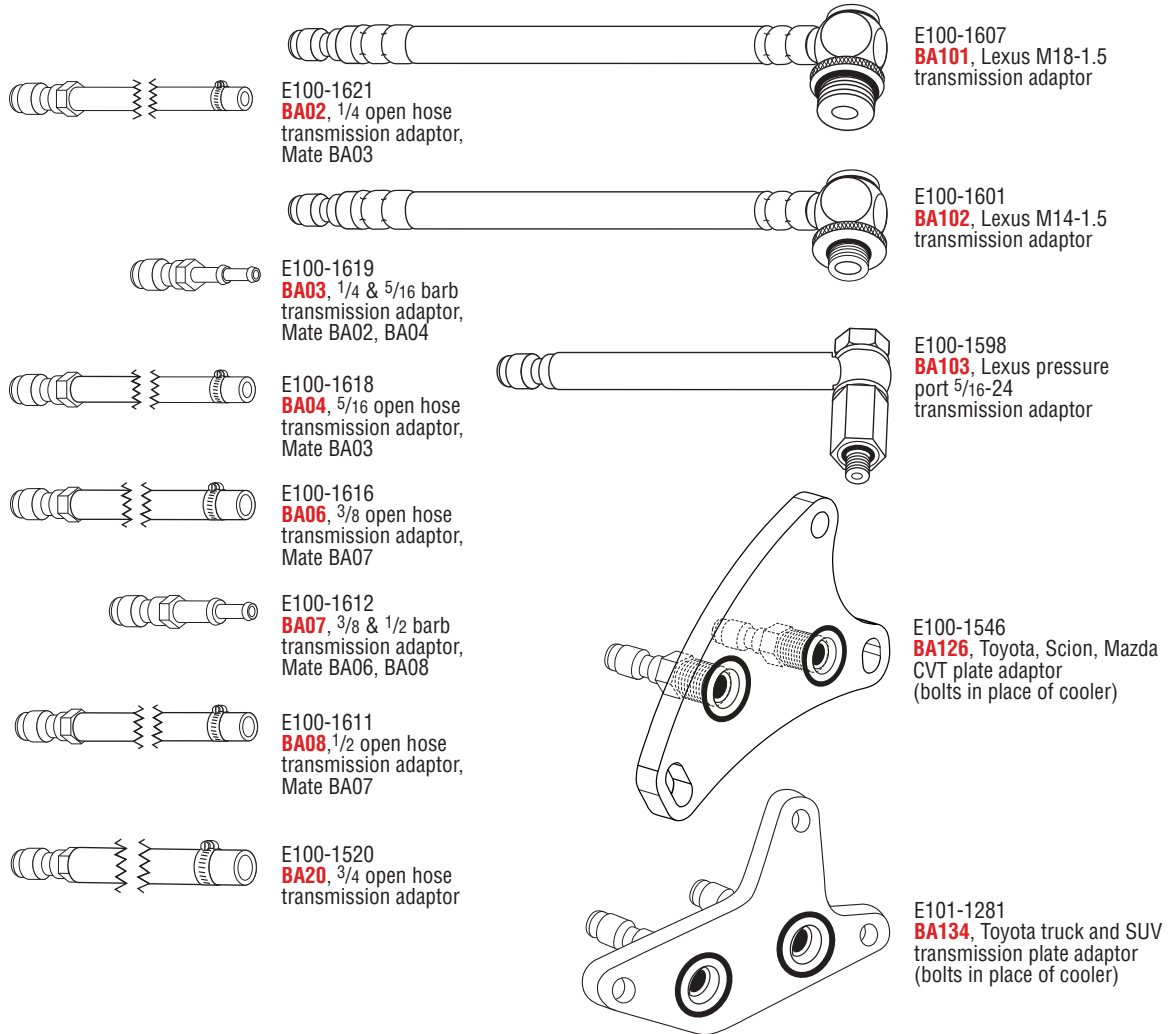

# Mazda Transmission Adaptor Set

PN E101-2572

For use with BG PXT<sup>®</sup>2, PXT<sup>®</sup>, and PF5H0

**RED** characters in part numbers are marked on adaptors

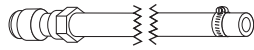

E100-1621  
**BA02**, 1/4 open hose  
transmission adaptor,  
Mate BA03



E100-1619  
**BA03**, 1/4 & 5/16 barb  
transmission adaptor,  
Mate BA02, BA04

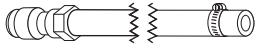

E100-1618  
**BA04**, 5/16 open hose  
transmission adaptor,  
Mate BA03



E100-1616  
**BA06**, 3/8 open hose  
transmission adaptor,  
Mate BA07

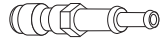

E100-1612  
**BA07**, 3/8 & 1/2 barb  
transmission adaptor,  
Mate BA06, BA08

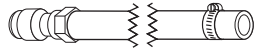

E100-1611  
**BA08**, 1/2 open hose  
transmission adaptor,  
Mate BA07

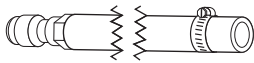

E100-1520  
**BA20**, 3/4 open hose  
transmission adaptor

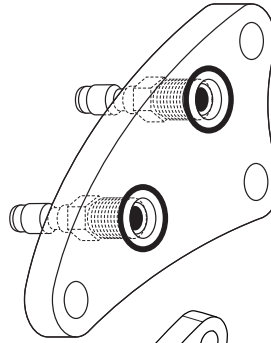

E100-1569  
**BA116**, Mazda transmission  
plate adaptor  
(bolts in place of cooler)

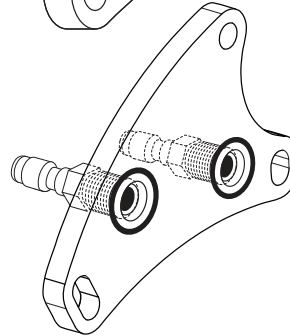

E100-1546  
**BA126**, Toyota, Scion, Mazda  
CVT plate adaptor  
(bolts in place of cooler)



# Mercedes Benz Transmission Adaptor Set

PN E101-2573

For use with BG PXT<sup>®</sup>2, PXT<sup>®</sup> and PF5H0

**RED** characters in part numbers are marked on adaptors

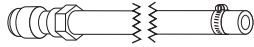

E100-1621  
**BA02**, 1/4 open hose  
transmission adaptor,  
Mate BA03



E100-1619  
**BA03**, 1/4 & 5/16 barb  
transmission adaptor,  
Mate BA02, BA04

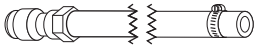

E100-1618  
**BA04**, 5/16 open hose  
transmission adaptor,  
Mate BA03



E100-1616  
**BA06**, 3/8 open hose  
transmission adaptor,  
Mate BA07



E100-1612  
**BA07**, 3/8 & 1/2 barb  
transmission adaptor,  
Mate BA06, BA08



E100-1611  
**BA08**, 1/2 open hose  
transmission adaptor,  
Mate BA07



E100-1520  
**BA20**, 3/4 open hose  
transmission adaptor



E100-1511  
**BA28**, GM, CDJR, Mercedes 3/8  
male QC transmission adaptor,  
Mate BA72

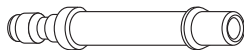

E100-1495  
**BA33**, GM, Ford, Mercedes 1/2  
male QC transmission adaptor,  
Mate BA79



E100-1449  
**BA52**, BMW, Mercedes male flare  
M16-1.5 transmission adaptor,  
Mate BA52F

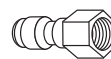

E100-1488  
**BA52F**, BMW, Mercedes female flare  
M16-1.5 transmission adaptor,  
Mate BA52

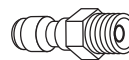

E100-1445  
**BA53**, BMW, Audi male flare  
M18-1.5 transmission adaptor,  
Mate BA53F

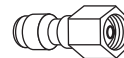

E100-1444  
**BA53F**, BMW, Audi female flare  
M18-1.5 transmission adaptor,  
Mate BA53, BA135



E100-1423  
**BA60**, Mercedes male  
QC transmission adaptor,  
Mate BA60F

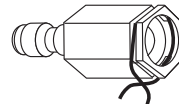

E100-1422  
**BA60F** Mercedes female QC  
transmission adaptor,  
Mate BA60

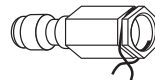

E100-1393  
**BA72**, GM, CDJR, Mercedes 3/8 female  
QC transmission adaptor,  
Mate BA25, BA28, BA113

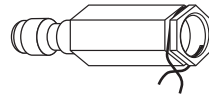

E100-1372  
**BA79**, CDJR, Mercedes, Ford, GM 1/2  
female QC transmission adaptor,  
Mate BA26, BA33, BA141

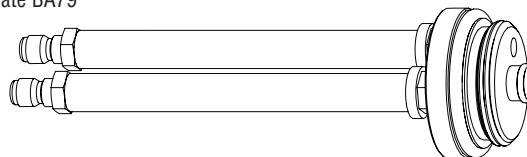

E101-1958  
**BA144** Mercedes Transmission  
filter adaptor



# Mini Transmission Adaptor Set

PN E101-2574

For use with BG PXT<sup>®</sup>2, PXT<sup>®</sup> and PF5H0

**RED** characters in part numbers are marked on adaptors

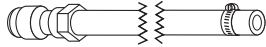

E100-1621  
**BA02**, 1/4 open hose  
transmission adaptor,  
Mate BA03



E100-1619  
**BA03**, 1/4 & 5/16 barb  
transmission adaptor,  
Mate BA02, BA04



E100-1618  
**BA04**, 5/16 open hose  
transmission adaptor,  
Mate BA03



E100-1616  
**BA06**, 3/8 open hose  
transmission adaptor,  
Mate BA07

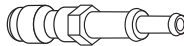

E100-1612  
**BA07**, 3/8 & 1/2 barb  
transmission adaptor,  
Mate BA06, BA08

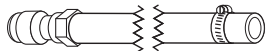

E100-1611  
**BA08**, 1/2 open hose  
transmission adaptor,  
Mate BA07



E100-1520  
**BA20**, 3/4 open hose  
transmission adaptor



E100-1512  
**BA27**, Ford 5/16 spike  
QC transmission adaptor,  
Mate BA80

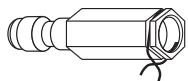

E100-1367  
**BA80**, Ford 5/16 female  
QC transmission adaptor,  
Mate BA27

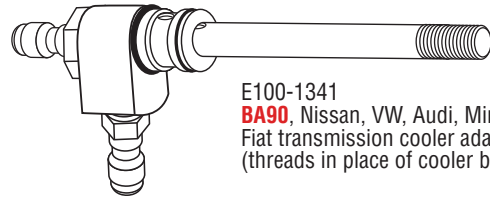

E100-1341  
**BA90**, Nissan, VW, Audi, Mini,  
Fiat transmission cooler adaptor  
(threads in place of cooler bolt)

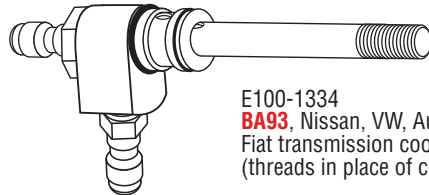

E100-1334  
**BA93**, Nissan, VW, Audi, Mini,  
Fiat transmission cooler adaptor  
(threads in place of cooler bolt)

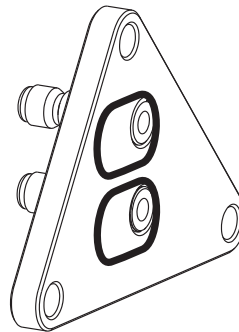

E101-1346  
**BA138**, mini transmission  
cooler adaptor



# Mitsubishi Transmission Adaptor Set

PN E101-2575

For use with BG PXT<sup>®</sup>2, PXT<sup>®</sup>, and PF5H0

**RED** characters in part numbers are marked on adaptors

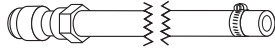

E100-1621  
**BA02**, 1/4 open hose  
transmission adaptor,  
Mate BA03



E100-1619  
**BA03**, 1/4 & 5/16 barb  
transmission adaptor,  
Mate BA02, BA04



E100-1618  
**BA04**, 5/16 open hose  
transmission adaptor,  
Mate BA03



E100-1616  
**BA06**, 3/8 open hose  
transmission adaptor,  
Mate BA07

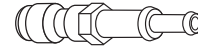

E100-1612  
**BA07**, 3/8 & 1/2 barb  
transmission adaptor,  
Mate BA06, BA08



E100-1611  
**BA08**, 1/2 open hose  
transmission adaptor,  
Mate BA07

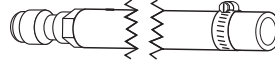

E100-1520  
**BA20**, 3/4 open hose  
transmission adaptor

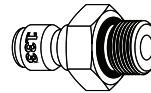

E101-1218  
**BA133**, Nissan, Mitsubishi  
M14-1.0 CVT adaptor



# Mopar Transmission Adaptor Set

PN E101-2576

For use with BG PXT<sup>®</sup>2, PXT<sup>®</sup> and PF5H0

**RED** characters in part numbers are marked on adaptors

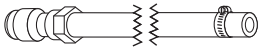

E100-1621  
**BA02**, 1/4 open hose  
transmission adaptor,  
Mate BA03



E100-1619  
**BA03**, 1/4 & 5/16 barb  
transmission adaptor,  
Mate BA02, BA04

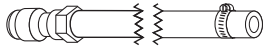

E100-1618  
**BA04**, 5/16 open hose  
transmission adaptor,  
Mate BA03

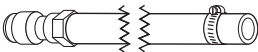

E100-1616  
**BA06**, 3/8 open hose  
transmission adaptor,  
Mate BA07

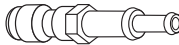

E100-1612  
**BA07**, 3/8 & 1/2 barb  
transmission adaptor,  
Mate BA06, BA08

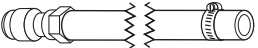

E100-1611  
**BA08**, 1/2 open hose  
transmission adaptor,  
Mate BA07



E100-1520  
**BA20**, 3/4 open hose  
transmission adaptor

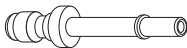

E100-1514  
**BA25**, Ford, CDJR 3/8 male  
spike QC transmission adaptor,  
Mate BA72

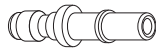

E100-1513  
**BA26**, CDJR 1/2 male spike QC  
transmission adaptor,  
Mate BA79



E100-1588  
**BA107**, Nissan, Ford, CDJR pressure port  
M10-1.0 transmission adaptor



E100-1512  
**BA27**, Ford 5/16 spike QC  
transmission adaptor, Mate BA80



E100-1511  
**BA28**, GM, CDJR, Mercedes 3/8  
male QC transmission adaptor,  
Mate BA72

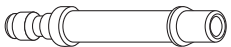

E100-1495  
**BA33**, GM, Ford, Mercedes 1/2 male  
QC transmission adaptor,  
Mate BA79

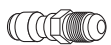

E100-1477  
**BA40**, CDJR 5/16 male flare  
9/16 -24 transmission adaptor,  
Mate BA41

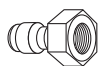

E100-1475  
**BA41**, CDJR 5/16 female flare  
9/16 -24 transmission adaptor,  
Mate BA40

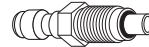

E100-1466  
**BA45**, CDJR male 5/8 -18  
transmission adaptor,  
Mate BA77

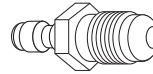

E100-1462  
**BA48**, CDJR male 11/16 -16  
transmission adaptor,  
Mate BA49

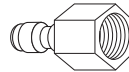

E100-1459  
**BA49**, CDJR female 11/16 -16  
transmission adaptor,  
Mate BA48

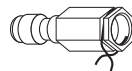

E100-1393  
**BA72**, GM, CDJR, Mercedes 3/8  
female QC transmission adaptor,  
Mate BA25, BA28, BA113

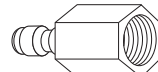

E100-1378  
**BA77**, CDJR female 5/8-18  
transmission adaptor,  
Mate BA45

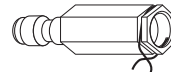

E100-1372  
**BA79**, CDJR, Mercedes, Ford, GM 1/2  
female QC transmission adaptor,  
Mate BA26, BA33, BA141

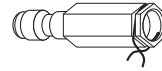

E100-1367  
**BA80**, Ford 5/16 female  
QC transmission adaptor,  
Mate BA27

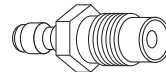

E100-1354  
**BA84**, 1/2 male long inverted  
flare 3/4-18 transmission adaptor,  
Mate BA85

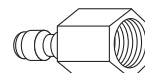

E100-1351  
**BA85**, 1/2 female long inverted  
flare 3/4-18 transmission adaptor,  
Mate BA84

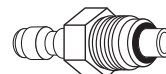

E100-1553  
**BA122**, CDJR male M20-1.5  
transmission adaptor,  
Mate BA123

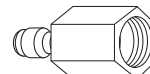

E100-1551  
**BA123**, CDJR female M20-1.5  
transmission adaptor,  
Mate BA122

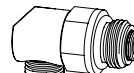

E100-1543  
**BA127**, CDJR, Hyundai, Genesis  
M18-1.5 transmission adaptor



E101-1932  
**BA145**, Transmission block off  
adaptor



# Nissan Transmission Adaptor Set

PN E101-2577

For use with BG PXT<sup>®</sup>2, PXT<sup>®</sup> and PF5H0

**RED** characters in part numbers are marked on adaptors

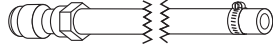

E100-1621  
**BA02**, 1/4 open hose  
transmission adaptor,  
Mate BA03



E100-1619  
**BA03**, 1/4 & 5/16 barb  
transmission adaptor,  
Mate BA02, BA04



E100-1618  
**BA04**, 5/16 open hose  
transmission adaptor,  
Mate BA03



E100-1616  
**BA06**, 3/8 open hose  
transmission adaptor,  
Mate BA07

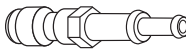

E100-1612  
**BA07**, 3/8 & 1/2 barb  
transmission adaptor,  
Mate BA06, BA08



E100-1611  
**BA08**, 1/2 open hose  
transmission adaptor,  
Mate BA07

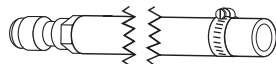

E100-1520  
**BA20**, 3/4 open hose  
transmission adaptor

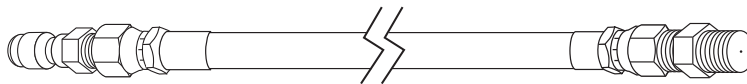

E100-1588  
**BA107**, Nissan, Ford, CDJR  
pressure port M10-1.0  
transmission adaptor

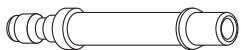

E100-1495  
**BA33**, GM, Ford, Mercedes 1/2 male  
QC transmission adaptor,  
Mate BA79

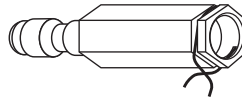

E100-1372  
**BA79**, CDJR, Mercedes, Ford, GM 1/2  
female QC transmission adaptor,  
Mate BA26, BA33, BA141

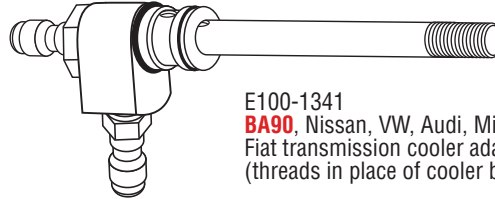

E100-1341  
**BA90**, Nissan, VW, Audi, Mini,  
Fiat transmission cooler adaptor  
(threads in place of cooler bolt)

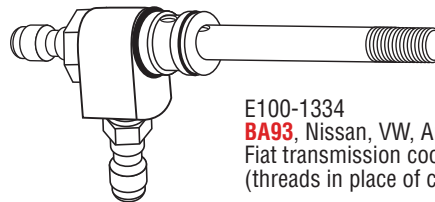

E100-1334  
**BA93**, Nissan, VW, Audi, Mini,  
Fiat transmission cooler adaptor  
(threads in place of cooler bolt)

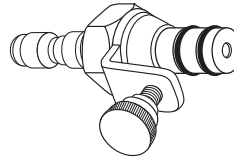

E100-1592  
**BA106**, Nissan CVT dip  
stick adaptor



E101-1218  
**BA133**, Nissan, Mitsubishi  
M14-1.0 CVT adaptor





# Porsche Transmission Adaptor Set

PN E101-2578

For use with BG PXT<sup>®</sup>2, PXT<sup>®</sup> and PF5H0

**RED** characters in part numbers are marked on adaptors

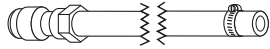

E100-1621  
**BA02**, 1/4 open hose  
transmission adaptor,  
Mate BA03



E100-1619  
**BA03**, 1/4 & 5/16 barb  
transmission adaptor,  
Mate BA02, BA04

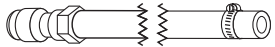

E100-1618  
**BA04**, 5/16 open hose  
transmission adaptor,  
Mate BA03



E100-1616  
**BA06**, 3/8 open hose  
transmission adaptor,  
Mate BA07

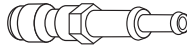

E100-1612  
**BA07**, 3/8 & 1/2 barb  
transmission adaptor,  
Mate BA06, BA08

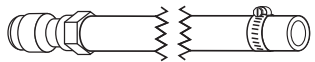

E100-1611  
**BA08**, 1/2 open hose  
transmission adaptor,  
Mate BA07

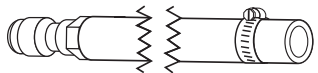

E100-1520  
**BA20**, 3/4 open hose  
transmission adaptor

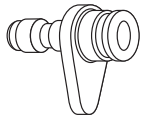

E100-1426  
**BA59**, Audi, VW, Porsche, BMW  
16.4mm male transmission adaptor,  
Mate BA59F

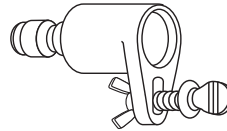

E100-1425  
**BA59F**, Audi, VW, Porsche, BMW  
16.4mm female transmission adaptor,  
Mate BA59

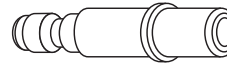

E100-1421  
**BA61**, BMW, Land Rover  
14mm male QC transmission  
adaptor, Mate BA61F

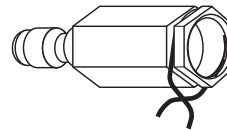

E100-1420  
**BA61F**, BMW, Land Rover  
14mm female QC transmission  
adaptor, Mate BA61



E100-1405  
**BA66**, BMW 14.3mm male  
transmission adaptor, Mate BA66F

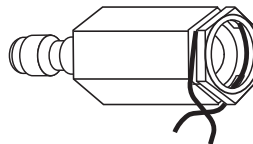

E100-1404  
**BA66F**, BMW 14.3mm female  
transmission adaptor, Mate BA66

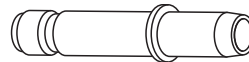

E101-1054  
**BA132**, Audi, Porsche, Hyundai,  
Kia, Genesis 12mm male  
transmission adaptor,  
Mate BA08



# Subaru Transmission Adaptor Set

PN E101-2579

For use with BG PXT<sup>®</sup>2, PXT<sup>®</sup>, and PF5H0

**RED** characters in part numbers are marked on adaptors

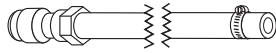

E100-1621  
**BA02**, 1/4 open hose  
transmission adaptor,  
Mate BA03



E100-1619  
**BA03**, 1/4 & 5/16 barb  
transmission adaptor,  
Mate BA02, BA04



E100-1618  
**BA04**, 5/16 open hose  
transmission adaptor,  
Mate BA03

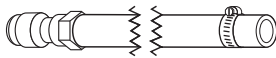

E100-1616  
**BA06**, 3/8 open hose  
transmission adaptor,  
Mate BA07

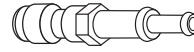

E100-1612  
**BA07**, 3/8 & 1/2 barb  
transmission adaptor,  
Mate BA06, BA08

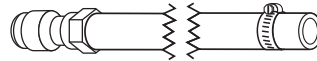

E100-1611  
**BA08**, 1/2 open hose  
transmission adaptor,  
Mate BA07

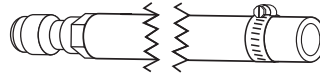

E100-1520  
**BA20**, 3/4 open hose  
transmission adaptor



# Suzuki Transmission Adaptor Set

PN E101-2580

For use with BG PXT<sup>®</sup>2, PXT<sup>®</sup>, and PF5H0

**RED** characters in part numbers are marked on adaptors

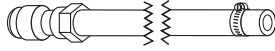

E100-1621  
**BA02**, 1/4 open hose  
transmission adaptor,  
Mate BA03

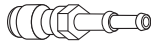

E100-1619  
**BA03**, 1/4 & 5/16 barb  
transmission adaptor,  
Mate BA02, BA04

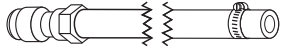

E100-1618  
**BA04**, 5/16 open hose  
transmission adaptor,  
Mate BA03

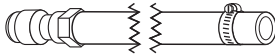

E100-1616  
**BA06**, 3/8 open hose  
transmission adaptor,  
Mate BA07

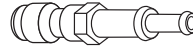

E100-1612  
**BA07**, 3/8 & 1/2 barb  
transmission adaptor,  
Mate BA06, BA08

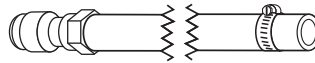

E100-1611  
**BA08**, 1/2 open hose  
transmission adaptor,  
Mate BA07

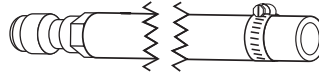

E100-1520  
**BA20**, 3/4 open hose  
transmission adaptor



# Toyota Transmission Adaptor Set

PN E101-2581

For use with BG PXT<sup>®</sup>2, PXT<sup>®</sup>, and PF5H0

**RED** characters in part numbers are marked on adaptors

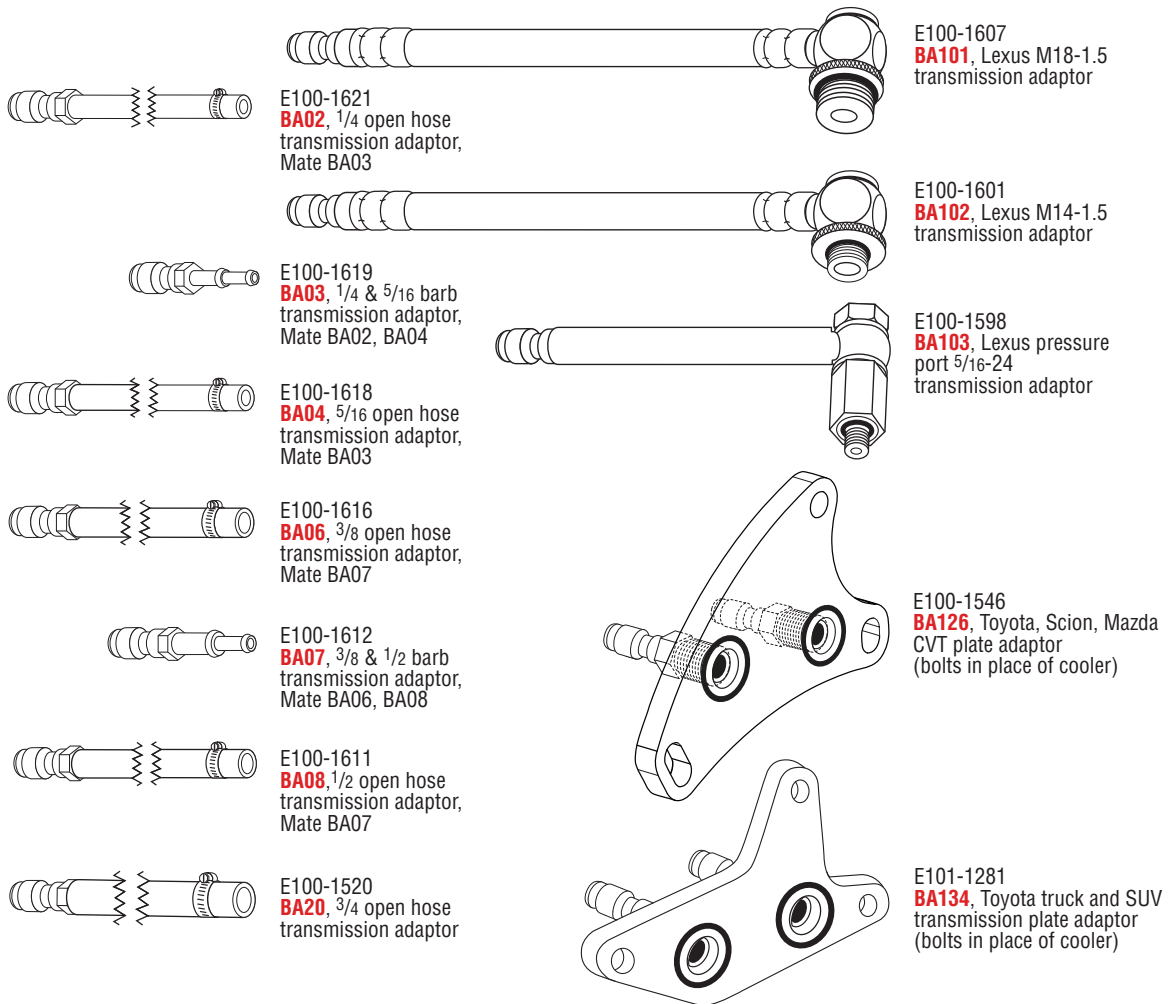

# Volvo Transmission Adaptor Set

PN E101-2582

For use with BG PXT<sup>®</sup>2, PXT<sup>®</sup> and PF5H0

**RED** characters in part numbers are marked on adaptors

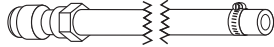

E100-1621  
**BA02**, 1/4 open hose  
transmission adaptor,  
Mate BA03

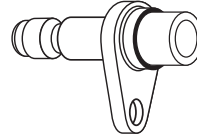

E100-1419  
**BA62**, Volvo 12mm male  
transmission adaptor,  
Mate BA62F



E100-1619  
**BA03**, 1/4 & 5/16 barb  
transmission adaptor,  
Mate BA02, BA04

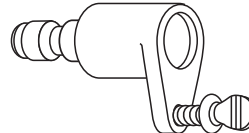

E100-1418  
**BA62F**, Volvo 12mm female  
transmission adaptor,  
Mate BA62

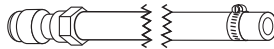

E100-1618  
**BA04**, 5/16 open hose  
transmission adaptor,  
Mate BA03

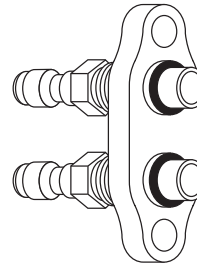

E100-1566  
**BA117**, Volvo US  
transmission adaptor



E100-1616  
**BA06**, 3/8 open hose  
transmission adaptor,  
Mate BA07

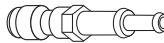

E100-1612  
**BA07**, 3/8 & 1/2 barb  
transmission adaptor,  
Mate BA06, BA08

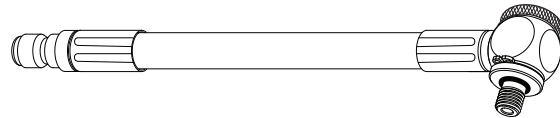

E100-1540  
**BA128**, VW, Volvo 90°  
swivel 5/16-24  
transmission adaptor



E100-1611  
**BA08**, 1/2 open hose  
transmission adaptor,  
Mate BA07

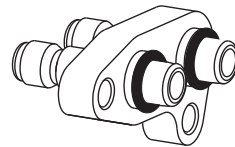

E101-1552  
**BA139**, Volvo EU  
transmission adaptor

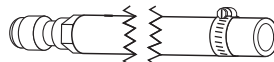

E100-1520  
**BA20**, 3/4 open hose  
transmission adaptor



E100-1437  
**BA55**, Volvo male  
transmission adaptor,  
Mate BA55F



E100-1434  
**BA55F**, Volvo female  
transmission adaptor,  
Mate BA55

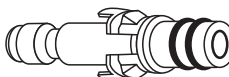

E100-1431  
**BA58**, Volvo male  
transmission adaptor  
with plastic clip,  
Mate BA58F



E100-1428  
**BA58F**, Volvo female  
transmission adaptor,  
Mate BA58



# VW Transmission Adaptor Set

PN E101-2583

For use with BG PXT<sup>®</sup>2, PXT<sup>®</sup>, and PF5H0

**RED** characters in part numbers are marked on adaptors

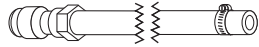

E100-1621  
**BA02**, 1/4 open hose  
transmission adaptor,  
Mate BA03



E100-1619  
**BA03**, 1/4 & 5/16 barb  
transmission adaptor,  
Mate BA02, BA04



E100-1618  
**BA04**, 5/16 open hose  
transmission adaptor,  
Mate BA03



E100-1616  
**BA06**, 3/8 open hose  
transmission adaptor,  
Mate BA07

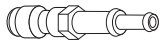

E100-1612  
**BA07**, 3/8 & 1/2 barb  
transmission adaptor,  
Mate BA06, BA08



E100-1611  
**BA08**, 1/2 open hose  
transmission adaptor,  
Mate BA07



E100-1520  
**BA20**, 3/4 open hose  
transmission adaptor



E100-1445  
**BA53**, BMW, Audi male flare  
M18-1.5 transmission adaptor,  
Mate BA53F

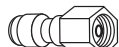

E100-1444  
**BA53F**, BMW, Audi female flare  
M18-1.5 transmission adaptor,  
Mate BA53, BA135



E100-1433  
**BA56**, VW, Audi single flange bolt  
transmission adaptor,  
(service requires 2)



E100-1432  
**BA57**, VW, Audi double flange bolt  
transmission adaptor,  
(service requires 2)

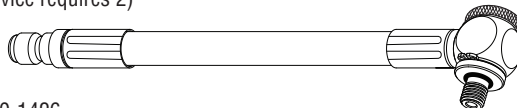

E100-1540  
**BA128**, VW, Volvo 90°  
swivel 5/16-24  
transmission adaptor

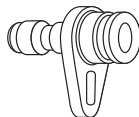

E100-1426  
**BA59**, Audi, VW, Porsche, BMW  
16.4mm male transmission adaptor,  
Mate BA59F

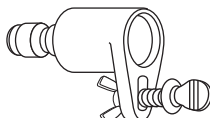

E100-1425  
**BA59F**, Audi, VW, Porsche, BMW  
16.4mm female transmission adaptor,  
Mate BA59

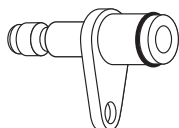

E100-1403  
**BA67**, Audi 14.8mm male  
transmission adaptor,  
Mate BA67F

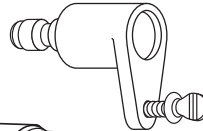

E100-1400  
**BA67F**, Audi 14.8mm female  
transmission adaptor,  
Mate BA67

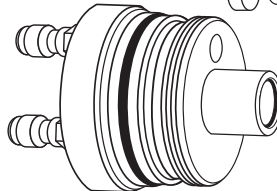

E100-1398  
**BA68**, VW, Audi DSG  
transmission adaptor,  
(spins on in place of  
the filter housing)

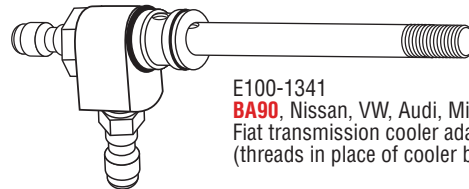

E100-1341  
**BA90**, Nissan, VW, Audi, Mini,  
Fiat transmission cooler adaptor  
(threads in place of cooler bolt)

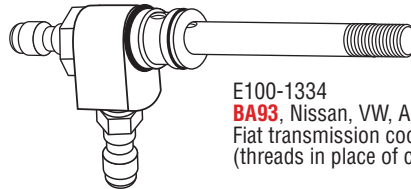

E100-1334  
**BA93**, Nissan, VW, Audi, Mini,  
Fiat transmission cooler adaptor  
(threads in place of cooler bolt)

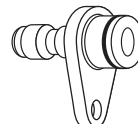

E100-1584  
**BA108**, VW 16.4mm male  
transmission adaptor,  
Mate BA109

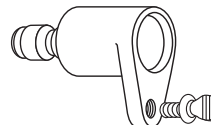

E100-1582  
**BA109**, VW 16.4mm female  
transmission adaptor,  
Mate BA108



E101-1054  
**BA132**, Audi, Porsche, Hyundai,  
Kia, Genesis 12mm male  
transmission adaptor,  
Mate BA08

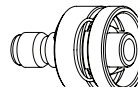

E101-1369  
**BA136**, Audi female QC  
transmission cooler adaptor,  
Mate BA137



E101-1337  
**BA137**, Audi male QC  
transmission cooler adaptor,  
Mate BA136

